



Table of Contents

Use this reference to quickly locate the products you want. Products are organized by section for easy navigation.



OFFICE SUITES

- Laminate..... 6-13
- Table Desks 14
- Steel..... 15



COMPUTER FURNITURE

- Sit-to-Stand 17-20

SEATING

- Reception Room 23-28
- Leather & Vinyl 30-37
- Mesh 38-46
- Office..... 47-49
- Big & Tall..... 50-52
- Stacking 53, 54
- Nesting 55
- Stools 56-59
- Folding..... 60, 61
- Footrests & Back Supports 62



FILES

- Lateral 64
- Pedestal 65, 66
- Mobile 67



STORAGE

- Shelving..... 69-72
- Cabinets 73
- Bookcases..... 74, 75
- Breakroom..... 76, 77



TABLES

- Hospitality..... 79
- Occasional..... 80
- Training 81
- Utility/Folding 82, 83



OFFICE FURNISHINGS

- Fans & Heaters..... 85
- Lamps 86
- Refrigerators 87

©ESND 2016 Printed in the U.S.A.

Prices shown are in U.S. dollars and are subject to change without notice; we encourage you to confirm prices when placing your order. We reserve the right to correct pricing or copy errors and to limit quantities. Company and product names appearing in this catalog are the trademarks of their respective owners. Products on the front cover may be for illustration only and may not be available for sale. Food, beverages, medicines and custom orders cannot be returned. Casters supplied with the chairs in this catalog may not be suitable for all floor types. Alternative casters are available.

Innovative solutions for the workplace



Well-being

Alera makes it easy to bring a more active workstyle to the office with a wide range of sit-to-stand workstations, height-adjustable tables and perch stools.

Open Plan

Keep team interaction high and aesthetics clean and modern. With Alera's modular components you can rearrange your space as your needs change.





Selection

With over 600 products to choose from, Alera has the perfect solution for the way you work. And, we're constantly enhancing our designs to meet the needs of the ever-changing workplace.

- Bookcases • Breakroom Cabinets
- Desks • Files • Seating
- Sit-to-Stand • Tables • Wire Shelving



Flexibility

Look to Alera for pieces that easily adapt to your work style and environment. Tables that reconfigure for conferencing and training. Breakrooms that double as collaborative spaces.



Versatility and Value by Design

ICON INDEX



Indicates a product that must be shipped freight.



Indicates a product that requires assembly.



Identifies items added since the last edition of this catalog.



Indicates the maximum weight a chair can support.



Products made with at least 10% total recycled content.



Because there is no universally accepted standard to designate products as environmentally preferable, we have adopted the green leaf symbol to highlight products that have one or more of the following attributes: reduced VOCs, compostable, biodegradable, contains recycled content, or other environmental attributes that make this product[†] less harmful to the environment or humans, when compared to its traditional counterparts. Many of the products marked with the green leaf symbol have been endorsed by third-party certifying organizations, and where applicable, the certifying body's logo appears next to the product's name. Please note that we have not independently verified the environmental attributes.

[†]These environmental attributes refer to the products themselves and not the processes for manufacturing and transporting the products.

THIRD-PARTY CERTIFICATIONS GUIDE



ANSI/BIFMA Certification Identifies products that meet or exceed ANSI/BIFMA standards for safety and durability.

ANSI/BIFMA certified furniture meets high standards for indoor air quality as well as safety and ergonomics in order to minimize health hazards and make injury less likely. Specific performance tests were developed by the Business and Institutional Furniture Manufacturer's Association (BIFMA) and approved by the American National Standards Institute (ANSI). These tests determine the stamina of casegoods and seating in their day-to-day use on a single work shift over ten years under both normal-use and excessive-use conditions.



CARB Compliant In January 2009, the California Air Resources Board (CARB), a department of the California Environmental Protection Agency,

implemented limits for formaldehyde emitted from composite wood panels. The California regulation governs the formaldehyde in both raw composite wood panels and finished products sold or used in California. Both imported and domestic products are regulated and must be third-party certified and clearly labeled to indicate they meet California's requirements.



ETL Listed The ETL Listed Mark (Electrical Testing Lab) is proof of product compliance (electrical, gas and oil-fired) to North American safety standards. Products that bear the ETL Listed Mark have met the minimum

requirements of widely accepted product safety standards as determined through the independent testing of Intertek, a Nationally Recognized Testing Laboratory (NRTL).



GREENGUARD® Indoor Air Quality Certified

Identifies goods with low chemical and particle emissions for use indoors, primarily building materials, interior furnishings, furniture, cleaning and maintenance products, electronic equipment and personal care products. The GREENGUARD® Environmental Institute governs the integrity of the certification process.



NSF Certification Identifies products certified as safe for food preparation, consumption and storage by NSF International.



SCS Indoor Advantage Gold™ Certified additional conformance with California 01350 Special Environmental Requirements and Collaborative for High Performance Schools (CHPS). In order for a product to qualify for the Indoor Advantage Gold certification, modeled concentrations for individual VOCs (volatile organic compounds) in classrooms and offices must not exceed one-half of the defined CREL (chronic reference exposure levels) threshold. CRELs have been developed for 80 chemical substances. Given that other (uncertified) products and materials in the building may be sources of the same chemicals, the conservative standard set for Indoor Advantage Gold certification is intended to ensure that individual occupants' overall exposure to any one of these chemicals does not exceed the CREL.



UL Listed Indicates that a product has been tested and certified as safe by Underwriters Laboratories Inc., an independent nonprofit organization that has developed more than 800 standards for safety. UL's web site is at <http://www.ul.com>. Information about UL standards can be found at ul.com/global/eng/pages/solutions/standards/

Office Suites

Create a space for the way you work.



A productive, personalized space is essential, even in this increasingly mobile world. We have the perfect pieces to shape your home base, whether you're looking for a full office suite or a sleek table desk, open plan design or private office. From traditional to contemporary, richly detailed to fresh, clean lines, our selection lets you put together an office that works for you.

Laminate Office Suites	6-13
Table Desks	14
Steel Office Suites	15



Sedina Series

A contemporary classic with clean lines and modern silver metalwork.

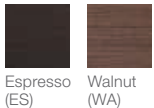

- Modular pieces configure in a variety of ways to create the perfect office.
- Thermally fused, textured woodgrain laminate is scratch-, dent- and water-resistant.
- Commercial-grade 1" thick elevated worksurfaces stand up to heavy use.

- Protective 3mm edge banding.
- Manufacturer's limited five-year warranty.
- Meets or exceeds ANSI/BIFMA Standards.



Preferred Settings

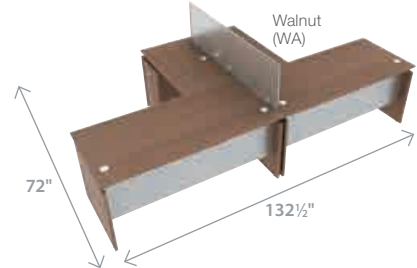
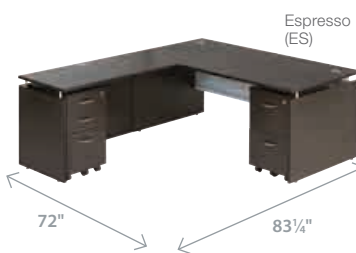

U-Workstation with Hutch

2,475.00

Qty.	Item No.	Description
1	ALE-SE217236WA	72" Straight Front Desk Shell
1	ALE-SE257224WA	72" Credenza Shell
1	ALE-SE267215WA	72" Hutch with Sliding Doors
1	ALE-SE234824WA	48" Reversible Return/Bridge Shell
1	ALE-SE531620WA	Mobile Three Drawer Pedestal

L-Workstation

1,686.00





































































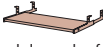

Qty.	Item No.	Description
1	ALE-SE217236ES	72" Straight Front Desk Shell
1	ALE-SE234824ES	48" Reversible Return/Bridge Shell
1	ALE-SE521620ES	Mobile Two Drawer Pedestal
1	ALE-SE531620ES	Mobile Three Drawer Pedestal

Teaming Station with Privacy Panel & Pedestals

2,594.00

Qty.	Item No.	Description
2	ALE-SE216630WA	66" Straight Front Desk Shell
2	ALE-SE234224WA	42" Reversible Return/Bridge Shell
2	ALE-SE531620WA	Mobile Three Drawer Pedestal
1	ALE-PP6518	65" Polycarbonate Privacy Panel

Selection Guide For Sedina Series

Espresso Modern Walnut SIZE (W x D x H) SHPG. WT. PRICE	Bow Front Desk Shell  Full-width metal modesty panel. Can be combined with Return/Bridge Shell and Credenza Shell to form a "L" or "U" workstation.	Straight Front Desk Shell  Full-width metal modesty panel. Can be combined with Return/Bridge Shell and Credenza Shell to form a "L" or "U" workstation.	Reversible Return/Bridge Shell  Use as a right- or left-handed return to create an "L" workstation or omit side leg and use as a bridge for "U" configurations. Not freestanding.	Credenza Shell  Can be combined with Return/Bridge Shell and Desk Shell to form an "L" or "U" workstation. Accommodates mobile and hanging pedestals.	
	ID DESK 1 ALE-SE227242ES 2 ALE-SE227242WA 72" x 42" x 29½" 141 lbs.   589.00	ID 72" ID 66" 3 ALE-SE217236ES 5 ALE-SE216630ES 4 ALE-SE217236WA 6 ALE-SE216630WA 72" x 36" x 29½" 66" x 30" x 29½" 136 lbs.   108 lbs.   569.00 479.00	ID 48" ID 42" 7 ALE-SE234824ES 9 ALE-SE234224ES 8 ALE-SE234824WA 10 ALE-SE234224WA 47¼" x 23½" x 29½" 42" x 23½" x 29½" 81 lbs.   68 lbs.   309.00 299.00	ID 72" ID 66" 11 ALE-SE257224ES 13 ALE-SE256624ES 12 ALE-SE257224WA 14 ALE-SE256624WA 72" x 23½" x 29½" 66" x 23½" x 29½" 113 lbs.   108 lbs.   419.00 389.00	
Espresso Modern Walnut SIZE (W x D x H) SHPG. WT. PRICE	Hutch with Sliding Doors  Compartmentalized storage with adjustable shelves and two sliding doors. 20½" clearance accommodates monitors.	Tackboard for Storage Hutch  Cloth-covered tack board. Includes mounting hardware.	Low File Cabinet Credenza  Use as a return to expand your desk space to create "L" or "U" shaped desk configurations. Three storage spaces including lateral file drawer, pencil drawer and open storage. Add cushion top to expand seating space.	Low Storage Cabinet Credenza  Use as a return to expand your desk space to create "L" or "U" shaped desk configurations. Sliding doors are removable for open storage. Add a coordinated cushion top to expand your seating space.	Lateral File  Freestanding or use under any workstation. Locking drawers with fold-away safety keys (included) for a slimmer profile.
	ID 72" ID 66" 15 ALE-SE267215ES 17 ALE-SE266615ES 16 ALE-SE267215WA 18 ALE-SE266615WA 72" x 15" x 42½" 66" x 15" x 42½" 175 lbs.   170 lbs.   759.00 729.00	ID FOR 66" OR 72" HUTCH 19 ALE-VA31-6614 62¾" x ½" x 14" 17 lbs.  130.00	ID 2 DRAWERS 20 ALE-LS583020ES 21 ALE-LS583020WA 29½" x 19½" x 22¾" 95 lbs.  309.00	22 ALE-LS593020ES 23 ALE-LS593020WA 29½" x 19½" x 22¾" 71 lbs.  349.00	24 ALE-VA513622ES 25 ALE-VA513622WA 34" x 22¾" x 29½" 149 lbs.  500.00
Espresso Modern Walnut Smoke Tan Quartz SIZE (W x D x H) SHPG. WT. PRICE	Mobile Box/File Pedestal  Full-extension ball bearing slides on file drawer for easy access. Two fold-away safety keys included. Accepts Alera® Pedestal Cushions for an instant seating option.	Seat Cushion  Soft resilient foam covered in soft long-lasting fabric. Rubber grip bottom surface holds cushion in place without slipping, but easily repositionable. Two-inch thick cushions offer just the right amount of support.	Mobile Pedestal File  Easily mobile on five casters (two locking); front center caster helps prevent tipping. Full extension drawers accommodates letter/legal filing. Locking with fold-away safety keys.	Mobile Pedestal File  Easily mobile on five casters (two locking); front center caster helps prevent tipping. Accommodates letter/legal filing.	Hanging Pedestal File  Not freestanding; mounts under any credenza or return. Accommodates letter/legal filing.
	ID 2 DRAWERS 26 ALE-VABFES 27 ALE-VABFWA 14¾" x 19½" x 22¾" 55 lbs.  299.00	ID LOW CREDENZA SEAT CUSHION ID PEDESTAL FILE SEAT CUSHION 28 ALE-PC3011 30 ALE-PC1511 29 ALE-PC3051 31 ALE-PC1551 29½" x 19½" x 2" 14¾" x 19½" x 2" 5 lbs.   3 lbs.   99.00 79.00	ID 3 DRAWERS 32 ALE-SE531620ES 33 ALE-SE531620WA 15¾" x 20" x 26¾" 70 lbs.  419.00	ID 2 DRAWERS 34 ALE-SE521620ES 35 ALE-SE521620WA 15¾" x 20" x 26¾" 68 lbs.  389.00	ID 2 DRAWERS 36 ALE-SE551622ES 37 ALE-SE551622WA 15¾" x 22" x 19" 63 lbs.  369.00
Espresso Modern Walnut SIZE (W x D x H) SHPG. WT. PRICE	Bookcase      Contemporary design; woodgrain laminate construction. Commercial-grade panels are water-, scratch- and dent-resistant, with protective 3 mm edge banding. 11¾" deep adjustable shelves. Top panel is 14¾" deep for door installation.				Bookcase Cabinet Door Kit  Use one kit to enclose 29½" high bookcase or lower portion of 40" high bookcase. Use two kits to fully enclose 55" high bookcase or lower and upper portion of 65" high bookcase. Use three kits to fully enclose 81" high bookcase. Lockable with two fold-over safety keys.
	ID 6 SHELVES ID 5 SHELVES ID 4 SHELVES ID 3 SHELVES ID 2 SHELVES 38 ALE-VA638232ES 40 ALE-VA636632ES 42 ALE-VA635632ES 44 ALE-VA634432ES 46 ALE-VA633032ES 39 ALE-VA638232WA 41 ALE-VA636632WA 43 ALE-VA635632WA 45 ALE-VA634432WA 47 ALE-VA633032WA 31¾" x 14" x 80¾" 31¾" x 14" x 65" 31¾" x 14" x 55" 31¾" x 14" x 39¾" 31¾" x 14" x 29½" 154 lbs.   129 lbs.   109 lbs.   77 lbs.   67 lbs.   420.00 330.00 280.00 230.00 210.00	ID 48 ALE-VA632832ES 49 ALE-VA632832WA 31¾" x 25¼" 19 lbs.  110.00			
Espresso Modern Walnut SIZE (W x D x H) SHPG. WT. PRICE	Polycarbonate Privacy Panel  Divides workspaces, but allows light to pass through. Secure clip-on attachment.	Round Conference Tables with Straight Leg Base  A popular style for quick-huddle setups or any conference room. Straight leg X-base included.	Underdesk Keyboard/Mouse Shelf  Attaches below worksurface and holds standard size keyboard. ¾" thick. Black.	Core Removable Lock and Key Set  Order one set per unit to key alike the workstation. Two fold away safety keys and one lock core included.	Under Cabinet LED Strip Lamp  Mount under hutches, cabinets, or on walls. Modern touch-sensitive dimming. Rotating frame swivels 360° for quick re-direction of the light. Includes AC adapter w/70" long cord and mounting hardware kit.
	ID 47" ID 65" 50 ALE-PP4718 51 ALE-PP6518 47" x ½" x 18" 65" x ½" x 18" 8 lbs. 11 lbs.  150.00 200.00	ID 42" DIAMETER—SEATS 4 PEOPLE. 52 ALE-VA7142ES 53 ALE-VA7142WA 42" dia. x 29½" 82 lbs.   350.00	ID 54 ALE-VA312812BK 28" x 12" x ¾" 11 lbs.  69.00	ID 55 ALE-VA50-1111 1 lb. 20.00	ID 12" WIDE ID 24" WIDE 56 ALE-LEDUC16B 57 ALE-LEDUC24B 12" x 2" 24" x 2" 2 lbs.  2 lbs.  49.00 69.00

17-AL-L-A3L

Office Suites Laminate



Valencia™ Series

Management office solutions featuring versatility to spare.

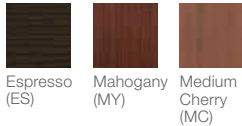

- Durable woodgrain laminate finishes.
- Commercial-grade 1" thick worksurface and side panels are water-, scratch- and dent-resistant, featuring protective edge banding.
- Matching finishes with Valencia Series desking and bookcase components.
- Leveling glides compensate for uneven floors.
- Manufacturer's limited five-year warranty.
- Meets or exceeds ANSI/BIFMA standards.



See more Alera products at www.aleradetails.com

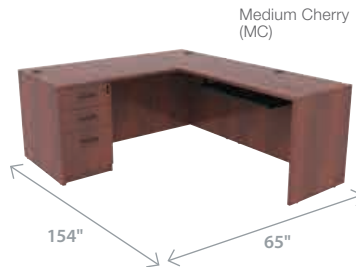
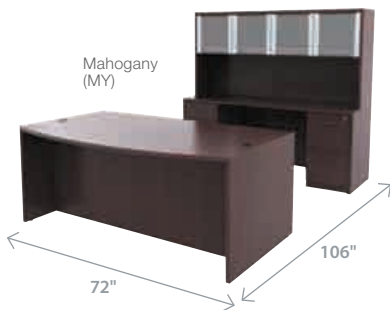

Desk & Credenza Workstation with Stack-on Storage **2,160.00**

Qty.	Item No.	Description
1	ALE-VA227236MY	Bow Front Desk Shell
1	ALE-VA257224MY	Credenza Shell
1	ALE-VA287215MY	Hutch
1	ALE-VA301730	Glass Door Set
1	ALE-VA542822MY	File/File Pedestal
1	ALE-VA532822MY	Box/Box/File Pedestal



















































































L-Workstation **939.00**

Qty.	Item No.	Description
1	ALE-VA216630MC	66" Desk Shell
1	ALE-VA354824MC	48" Return
1	ALE-VA532822MC	Box/Box/File Pedestal
1	ALE-VA312812BK	Keyboard Shelf

Desk with Full Pedestal **970.00**

Qty.	Item No.	Description
1	ALE-VA216630MY	66" Straight Front Desk
1	ALE-VA532822MY	Box/Box/File Pedestal
1	ALE-VA542822MY	File/File Pedestal

Selection Guide For Valencia Series

Espresso Mahogany Medium Cherry SIZE (W x D x H) SHPG. WT. PRICE	Bow Front Desk Shell  Arched front with 18" of overhang. Two grommets for wire management. Full-length modesty panel. Use with Return/Bridge Shell for an "L" desk; add a Credenza Shell for "U" workstation.			Straight Front Desk Shells  Combine with a Return/Bridge to create an "L" format desk, or add a Credenza to complete a full "U" workstation. Two wire management grommets. Full length modesty panel for privacy.				Mobile Workstation Desk  Slide-out keyboard tray. Two grommets for cable management. Undermount interior shelf for quick storage.				
	ID 72" 1 ALE-VA227236ES 2 ALE-VA22-7236MY 3 ALE-VA22-7236MC 71" x 41 1/2" x 29 1/2" 172 lbs.   420.00	ID 72" 4 ALE-VA217236ES 5 ALE-VA21-7236MY 6 ALE-VA21-7236MC 71" x 35 1/2" x 29 1/2" 150 lbs.   380.00	ID 66" 7 ALE-VA216630ES 8 ALE-VA21-6630MY 9 ALE-VA21-6630MC 65" x 29 1/2" x 29 1/2" 129 lbs.   330.00	ID 60" 10 ALE-VA216030ES 11 ALE-VA21-6030MY 12 ALE-VA21-6030MC 59 1/2" x 29 1/2" x 29 1/2" 120 lbs.   310.00	ID 48" 13 ALE-VA214830ES 14 ALE-VA21-4830MY 15 ALE-VA21-4830MC 47 1/2" x 29 1/2" x 29 1/2" 106 lbs.   280.00	ID 42" 16 ALE-VA204224ES 17 ALE-VA204224MY 18 ALE-VA204224MC 41 3/4" x 23 3/4" x 29 1/2" 99 lbs.   275.00						
Espresso Mahogany Medium Cherry SIZE (W x D x H) SHPG. WT. PRICE	D-Top Desk  Not freestanding. Use with Return/Bridge. One wire management grommet for D-tops.		Reversible Return/Bridge Shell  Universal application as either a return or bridge, in left or right-handed configurations. Create "U" or "L" shaped workstations. One wire management grommet.			Credenza Shell  Two wire management grommets. Full-height modesty panel. Use freestanding or combine with Return/Bridge Shell to form an "L" workstation; use with Desk Shell and Return/Bridge Shell to create a "U" workstation. Add an Open Storage Hutch or File Pedestal for expanded storage capabilities.						
	ID 72" 19 ALE-VA272736ES 20 ALE-VA27-7236MY 21 ALE-VA27-7236MC 71" x 35 1/2" x 29 1/2" 112 lbs.   430.00	ID 48" 22 ALE-VA354824ES 23 ALE-VA35-4824MY 24 ALE-VA35-4824MC 47 1/4" x 23 3/4" x 29 1/2" 83 lbs.   220.00	ID 42" 25 ALE-VA354224ES 26 ALE-VA354224MY 27 ALE-VA354224MC 42" x 23 3/4" x 29 1/2" 82 lbs.   210.00	ID 36" 28 ALE-VA353624ES 29 ALE-VA35-3624MY 30 ALE-VA35-3624MC 35" x 23 3/4" x 29 1/2" 66 lbs.   190.00	ID 72" 31 ALE-VA257224ES 32 ALE-VA25-7224MY 33 ALE-VA25-7224MC 70 7/8" x 23 3/4" x 29 1/2" 116 lbs.   300.00	ID 66" 34 ALE-VA256624ES 35 ALE-VA256624MY 36 ALE-VA256624MC 65" x 23 3/4" x 29 1/2" 115 lbs.   290.00	ID 60" 37 ALE-VA256024ES 38 ALE-VA25-6024MY 39 ALE-VA25-6024MC 59 1/8" x 23 3/4" x 29 1/2" 102 lbs.   270.00					
Espresso Mahogany Medium Cherry SIZE (W x D x H) SHPG. WT. PRICE	Corner Credenza Shell  Freestanding. Two wire management grommets. Full-length modesty panel.		Hutch  Fully finished back. Can be installed with included doors or without for easier access. Lighting valance and grommets to facilitate task lighting installation. Accommodates optional Alera® Tackboards and Alera® undermount lamp.			Organizer Hutch  Shelves adjust in 1" increments. 2 1/2" clearance accommodates most monitors.						
	ID RIGHT 40 ALE-VA25R7236ES 41 ALE-VA25R-7236MY 42 ALE-VA25R-7236MC 72" x 36" x 29 1/2" 157 lbs.   460.00	ID LEFT 43 ALE-VA25L7236ES 44 ALE-VA25L-7236MY 45 ALE-VA25L-7236MC 72" x 36" x 29 1/2" 157 lbs.   460.00	ID 70 1/4" 46 ALE-VA287215ES 47 ALE-VA287215MY 48 ALE-VA287215MC 70 3/4" x 15" x 35 1/2" 150 lbs.   480.00	ID 64 1/4" 49 ALE-VA286615ES 50 ALE-VA286615MY 51 ALE-VA286615MC 64 3/4" x 15" x 35 1/2" 139 lbs.   460.00	ID 58 1/4" 52 ALE-VA286015ES 53 ALE-VA286015MY 54 ALE-VA286015MC 58 7/8" x 15" x 35 1/2" 123 lbs.   400.00	ID 47" 55 ALE-VA284815ES 56 ALE-VA284815MY 57 ALE-VA284815MC 47" x 15" x 35 1/2" 107 lbs.   360.00	ID 58 ALE-VA267212ES 59 ALE-VA26-7212MY 60 ALE-VA26-7212MC 70 3/4" x 11 3/4" x 23 3/4" 96 lbs.   370.00					
Espresso Mahogany Medium Cherry SIZE (W x D x H) SHPG. WT. PRICE	Glass Door Set for Hutch  Silver framed. Includes mounting template and hardware. Four doors. Satin metal frame. Frosted glass.		Storage Cabinet  Adjustable shelf. Locking doors. Freestanding or use under worksurface.		Lateral File  Freestanding or use under any worksurface. Locking drawers with fold-away safety keys.		Full Pedestal File  Attaches under any worksurface, not freestanding. Two fold-away safety keys (included) for a slimmer profile.		Hanging Pedestal File  Attaches under any worksurface. Full extension drawers. Locking.		Mobile Pedestal File  Five casters, two locking.	
	ID 61 ALE-VA30-1730 17" x 16" 26 lbs.   320.00	ID 62 ALE-VA613622ES 63 ALE-VA61-3622MY 64 ALE-VA61-3622MC 34" x 22 3/4" x 29 1/2" 148 lbs.   420.00	ID 2 DRAWERS 65 ALE-VA513622ES 66 ALE-VA51-3622MY 67 ALE-VA51-3622MC 34" x 22 3/4" x 29 1/2" 149 lbs.   500.00	ID 3 DRAWERS 68 ALE-VA532822ES 69 ALE-VA53-2822MY 70 ALE-VA53-2822MC 15 5/8" x 20 1/2" x 28 1/2" 74 lbs.   320.00	ID 2 DRAWERS 71 ALE-VA542822ES 72 ALE-VA54-2822MY 73 ALE-VA54-2822MC 15 5/8" x 20 1/2" x 28 1/2" 74 lbs.   320.00	ID 2 DRAWERS 74 ALE-VA552222ES 75 ALE-VA55-2222MY 76 ALE-VA55-2222MC 15 5/8" x 20 1/2" x 19 1/4" 57 lbs.   270.00	ID 3 DRAWERS 77 ALE-VA572816ES 78 ALE-VA572816MY 79 ALE-VA572816MC 15 5/8" x 20 1/2" x 28 3/4" 77 lbs.   370.00					
Espresso Mahogany Medium Cherry Smoke Tan Quartz SIZE (W x D x H) SHPG. WT. PRICE	Mobile Box/File Pedestal  Full-extension ball bearing slides on file drawer for easy access. Two fold-away safety keys included. Accepts Alera® Pedestal Cushions.		Seat Cushion  Soft resilient foam covered in soft long-lasting fabric. Rubber grip bottom surface holds cushion in place without slipping, but easily repositionable. Fits Box/File Pedestals and Low Credenzas.		Low File Cabinet Credenza  Use for storage or as a low credenza, for "L" or "U" shaped configurations. Includes open storage and lateral/pencil drawers. Full extension drawers.		Low Storage Cabinet Credenza  Use for storage or as a low credenza for "L" or "U" shaped configurations. Sliding doors are removable for open storage.					
	ID 2 DRAWERS 80 ALE-VABFES 81 ALE-VABFMY 82 ALE-VABFMC 14 7/8" x 19 1/4" x 22 7/8" 55 lbs.   299.00	ID LOW CREDEZA SEAT CUSHION 83 ALE-PC3011 84 ALE-PC3051 29 1/2" x 19 1/4" x 2" 5 lbs.   99.00	ID PEDESTAL FILE SEAT CUSHION 85 ALE-PC1511 86 ALE-PC1551 14 7/8" x 19 1/4" x 2" 3 lbs.   79.00	ID 2 DRAWERS 87 ALE-LS583020ES 88 ALE-LS583020MY 89 ALE-LS583020MC 29 1/2" x 19 1/4" x 22 7/8" 95 lbs.   399.00	ID 90 ALE-LS593020ES 91 ALE-LS593020MY 92 ALE-LS593020MC 29 1/2" x 19 1/4" x 22 7/8" 71 lbs.   349.00							

Office Suites Laminate



Valencia Series

Management office solutions featuring versatility to spare.



- Durable woodgrain laminate finishes.
- Commercial-grade 1" thick worksurface and side panels are water-, scratch- and dent-resistant, featuring protective edge banding.
- Matching finishes with Valencia Series desking and bookcase components.

- Leveling glides compensate for uneven floors.
- Manufacturer's limited five-year warranty.
- Meets or exceeds ANSI/BIFMA Standards.



Preferred Settings

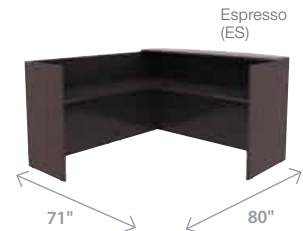
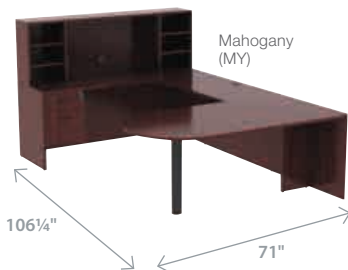
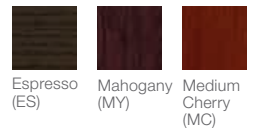

U-Workstation with Organizer Hutch

1,590.00

Qty.	Item No.	Description
1	ALE-VA27-7236MY	D-Top Desk
1	ALE-VA35-4824MY	48" Reversible Return/Bridge Shell
1	ALE-VA25-7224MY	72" Credenza Shell
1	ALE-VA26-7212MY	Organizer Hutch
1	ALE-VA55-2222MY	Hanging Box/File Pedestal

L-Workstation with Organizer Hutch

1,260.00





















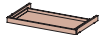
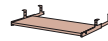























Qty.	Item No.	Description
1	ALE-VA27-7236MC	D-Top Desk
1	ALE-VA35-3624MC	36" Reversible Return/Bridge
1	ALE-VA26-7212MC	Organizer Hutch
1	ALE-VA55-2222MC	Hanging Box/File Pedestal

L-Reception Workstation

900.00

Qty.	Item No.	Description
1	ALE-VA324424ES	44" Reversible Reception Return
1	ALE-VA327236ES	72" Reception Desk with Transition Counter

Selection Guide For Valencia Series

<p>Reception Desk with Transaction Counter</p>  <p>Two grommets for cable and wire management. Include 1" thick wood front transaction counter.</p>	<p>Reversible Reception Return</p>  <p>Combine with Reception Desk to create an L-shaped workstation for transacting business or welcoming guests. Adapts to right- or left-handed configurations.</p>	<p>Tackboard for Storage Hutch</p>  <p>Cloth-covered tack board. Includes mounting hardware.</p>			<p>Under-Counter File Organizer</p>  <p>Use on desk or under reception counters.</p>		
		<p>ID 2 DRAWERS</p> <p>Espresso 1 ALE-VA327236ES Mahogany 2 ALE-VA327236MY Medium Cherry 3 ALE-VA327236MC</p> <p>SIZE (W x D x H) 71" x 35½" x 29½"</p> <p>SHPG. WT. 202 lbs.  </p> <p>PRICE 590.00</p>	<p>ID</p> <p>4 ALE-VA324424ES 5 ALE-VA324424MY 6 ALE-VA324424MC</p> <p>44" x 23½" x 41½"</p> <p>67 lbs.  </p> <p>310.00</p>	<p>ID FOR 66" OR 72" HUTCH</p> <p>7 ALE-VA31-6614</p> <p>62¾" x 1½" x 14"</p> <p>17 lbs. </p> <p>130.00</p>		<p>ID FOR 60" OPEN STORAGE HUTCH</p> <p>8 ALE-VA31-5414</p> <p>55" x 1½" x 14"</p> <p>15 lbs. </p> <p>120.00</p>	<p>ID FOR 48" OPEN STORAGE HUTCH AND RECEPTION RETURN</p> <p>9 ALE-VA31-4214</p> <p>43½" x 1½" x 14"</p> <p>12 lbs. </p> <p>110.00</p>
<p>Center Drawer</p>  <p>Mounts under any desk, credenza, return or bridge.</p>	<p>Underdesk Keyboard/Mouse Shelf</p>  <p>Attaches below worksurface and holds standard size keyboard. ¾" thick. Black.</p>	<p>Under Cabinet LED Strip Lamp</p>  <p>Mount under hutches, cabinets, or walls. Modern touch-sensitive dimming. Rotating frame swivels 360° for fast quick re-direction of the light. Includes AC adapter w/70' long cord and mounting hardware kit.</p>		<p>Core Removable Lock and Key Set</p>  <p>Order one set per unit to key alike the workstation. Two fold away safety keys and one lock core included.</p>	<p>Round Conference Tables with Straight Leg Base</p>  <p>A popular style for quick-huddle setups or any conference room. Straight leg X-base included.</p>		
		<p>ID 24¾" WIDE</p> <p>Espresso 13 ALE-VA312414ES Mahogany 14 ALE-VA312414MY Medium Cherry 15 ALE-VA312414MC</p> <p>SIZE (W x D x H) 24½" x 15" x 2"</p> <p>SHPG. WT. 8 lbs. </p> <p>PRICE 80.00</p>	<p>ID</p> <p>16 ALE-VA312812BK</p> <p>28" x 12" x ¾"</p> <p>13 lbs. </p> <p>69.00</p>			<p>ID</p> <p>17 ALE-LEDUC16B</p> <p>12" x 2"</p> <p>24 lbs. </p> <p>49.00</p>	<p>ID</p> <p>18 ALE-LEDUC24B</p> <p>24" x 2"</p> <p>27 lbs. </p> <p>69.00</p>
<p>Alera® Monitor Arms</p>  <p>Strong durable construction withstand the rigors of the busy office. Vesa Pattern compatible. Easy to install clamp or grommet mounting fits desk up to 4" thick and grommets up to 2¾" in diameter. Saves valuable desk space. Monitor angle and rotation adjustments. Use with Alera® Sit-Stand Lifting Workstations and Valencia or Sedina Open Office lines of desks.</p>	<p>Alera® Sit-Stand Lifting Workstation</p>  <p>Raise and lower with ease within a 14" range by pressing the levers on each side to engage. Two-tiered worksurface and keyboard/mouse platform. Accommodates most monitor arms. Raises vertically. Reinforced base for stability at any height. Will not flip or height-drop even when leaning on the workstation.</p>						
	<p>ID SINGLE MONITOR WITH USB—UP TO 32", UP TO 25 LBS.</p> <p>23 ALE-AEMA1H</p> <p>40 lbs. </p> <p>219.00</p>	<p>ID DUAL MONITORS WITH USB/AUDIO—UP TO 32", UP TO 25 LBS. PER ARM.</p> <p>24 ALE-AEMA2H</p> <p>35 lbs. </p> <p>399.00</p>	<p>ID SINGLE MONITOR—UP TO 27", UP TO 15 LBS.</p> <p>25 ALE-AEMA1L</p> <p>38 lbs. </p> <p>189.00</p>	<p>ID DUAL MONITORS—UP TO 27", UP TO 15 LBS. PER ARM.</p> <p>26 ALE-AEMA2L</p> <p>35 lbs. </p> <p>349.00</p>	<p>ID SINGLE MONITOR—UP TO 30", UP TO 25 LBS.</p> <p>27 ALE-AEMA1B</p> <p>39 lbs. </p> <p>139.00</p>	<p>ID DUAL MONITORS—UP TO 30", UP TO 25 LBS. PER ARM.</p> <p>28 ALE-AEMA2B</p> <p>42 lbs. </p> <p>249.00</p>	<p>ID</p> <p>29 ALE-AEWR1B</p> <p>26¾" x 23½"</p> <p>44 lbs. </p> <p>549.00</p>
<p>Bookcase</p>  <p>Contemporary design; woodgrain laminate construction. Commercial-grade panels are water-, scratch- and dent-resistant, with protective 3 mm edge banding. 11¾" deep adjustable shelves. Top panel is 14½" deep for door installation. Tight, dowel and cam-lock assembly. Matching components with Valencia Office Suites.</p>	<p>Bookcase Cabinet Door Kit</p>  <p>Use one kit to enclose 29½" high bookcase or lower portion of 40" high bookcase. Use two kits to fully enclose 55" high bookcase or lower and upper portion of 65" high bookcase. Use three kits to fully enclose 81" high bookcase. Lockable with two fold-over safety keys.</p>						
	<p>ID 6 SHELVES</p> <p>Espresso 31 ALE-VA638232ES Mahogany 32 ALE-VA63-8232MY Medium Cherry 33 ALE-VA63-8232MC</p> <p>31¾" x 14" x 80¾"</p> <p>154 lbs.  </p> <p>420.00</p>	<p>ID 5 SHELVES</p> <p>34 ALE-VA636632ES 35 ALE-VA63-6632MY 36 ALE-VA63-6632MC</p> <p>31¾" x 14" x 65"</p> <p>129 lbs.  </p> <p>330.00</p>	<p>ID 4 SHELVES</p> <p>37 ALE-VA635632ES 38 ALE-VA63-5632MY 39 ALE-VA63-5632MC</p> <p>31¾" x 14" x 55"</p> <p>109 lbs.  </p> <p>280.00</p>	<p>ID 3 SHELVES</p> <p>40 ALE-VA634432ES 41 ALE-VA63-4432MY 42 ALE-VA63-4432MC</p> <p>31¾" x 14" x 39¾"</p> <p>77 lbs.  </p> <p>230.00</p>	<p>ID 2 SHELVES</p> <p>43 ALE-VA633032ES 44 ALE-VA63-3032MY 45 ALE-VA63-3032MC</p> <p>31¾" x 14" x 29½"</p> <p>67 lbs.  </p> <p>210.00</p>	<p>ID</p> <p>46 ALE-VA632832ES 47 ALE-VA63-2832MY 48 ALE-VA63-2832MC</p> <p>31¾" x 25¼"</p> <p>19 lbs. </p> <p>110.00</p>	
<p>Polycarbonate Privacy Panel</p>  <p>Divides workspaces, but allows light to pass through. Secure clip-on attachment; Fits Valencia Desk Shells only.</p>	<p>Optional Grommets</p>  <p>Silver metal. Replaces standard black plastic grommets. 2 per pack.</p>		<p>Alera® Anti-Fatigue Mat</p>  <p>Beveled edge lays flat to reduce trip hazards. Rubber & vinyl construction ensures long lasting resiliency and cushioning.</p>		<p>Optional Drawer Pull</p>  <p>Silver metal. Replaces standard black metal pulls. 2 per set.</p>		
	<p>ID 47"</p> <p>49 ALE-PP4718</p> <p>47" x 1½" x 18"</p> <p>8 lbs.</p> <p>PRICE 150.00</p>	<p>ID 65"</p> <p>50 ALE-PP6518</p> <p>65" x 1½" x 18"</p> <p>11 lbs.</p> <p>200.00</p>	<p>ID</p> <p>51 ALE-VA503333</p> <p>60.00</p>	<p>ID</p> <p>52 ALE-AE23AFM</p> <p>24" x 36"</p> <p>99.00</p>		<p>ID</p> <p>53 ALE-VA5020</p> <p>20.00</p>	

17-AL-L-A3L



Open Office Desk Series

Modular light scale desking.

- Durable steel frame adjusts to fit standard 48" to 72" wide work surfaces.
- Scratch, dent and spill resistant thermally fused laminate work surfaces.
- Low-profile, practical storage solutions.
- Mix-and-match components and color options.
- Simple to assemble; easy to re-configure.
- Manufacturer's limited five-year warranty.
- Meets or exceeds ANSI/BIFMA Standards.

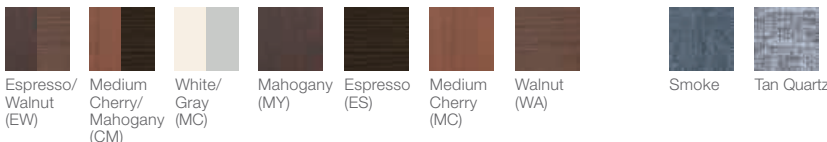

Selection Guide For Open Office Desk Series

		Work Surfaces/Table Tops					Adjustable O-Leg Desk Base	
		Reversible table tops have a different color and pattern on each side with coordinating dark gray edge banding. Use with Alera® bases to create height adjustable workstations, training tables, collaborative spaces or standard desks. Coordinating colors with Alera® Valencia and Sedina Office Suites. Commercial grade, 1" thick top. Table tops and bases sold and shipped separately—ORDER BOTH.					Contemporary open plan O-leg design is width adjustable to accommodate almost any size tabletops. Coordinates with Alera® Reversible Laminate Tabletops. Includes two full length O-leg supports and one short O-leg support.	
		ID 72" x 30"	ID 72" x 24"	ID 60" x 30"	ID 60" x 24"	ID 48" x 24"	ID 30" DEPTH	ID 24" DEPTH
Espresso/Walnut		1 ALE-TT7230EW	4 ALE-TT7224EW	7 ALE-TT6030EW	10 ALE-TT6024EW	13 ALE-TT4824EW	16 ALE-LSTB30GR	17 ALE-LSTB24GR
Medium Cherry/Mahogany		2 ALE-TT7230CM	5 ALE-TT7224CM	8 ALE-TT6030CM	11 ALE-TT6024CM	14 ALE-TT4824CM	16 ALE-LSTB30GR	17 ALE-LSTB24GR
White/Gray		3 ALE-TT7230WG	6 ALE-TT7224WG	9 ALE-TT6030WG	12 ALE-TT6024WG	15 ALE-TT4824WG	16 ALE-LSTB30GR	17 ALE-LSTB24GR
SIZE (W x D x H)		71½" x 29½"	71½" x 23½"	59½" x 29½"	59½" x 23½"	47½" x 23½"	47¼" to 70¾", 29½"d x 28½"h	47¼" to 70¾", 23¾"d x 28½"h
SHPG. WT.		62 lbs.	51 lbs.	52 lbs.	43 lbs.	36 lbs.	60 lbs. ✖	55 lbs. ✖
PRICE		249.00	159.00	189.00	139.00	139.00	399.00	379.00
		Hutch	Low File Cabinet Credenza	Low Storage Cabinet Credenza	Lateral File	Mobile Box/File Pedestal		
		Sliding doors keep items easily within reach and can be omitted for even easier access. Includes mounting tape and hardware.	Use as a return to expand your desk space to create "L" or "U" shaped desk configurations. Also accepts Alera® seat cushions. Three storage spaces including lateral file drawer, pencil drawer and open storage.	Use as a return to expand your desk space to create "L" or "U" shaped desk configurations. Sliding doors are removable for open storage.	Freestanding or use under any worksurface. Locking drawers with fold-away safety keys (included) for a slimmer profile.	Full-extension ball bearing slides on file drawer for easy access. Two fold-away safety keys included. Accepts Alera® seat cushions.		
		ID	ID 29¼" WIDE FILES	ID	34" WIDE FILES	ID TWO DRAWERS		
Espresso		18 ALE-LSHH60ES	22 ALE-LS583020ES	26 ALE-LS593020ES	30 ALE-VA513622ES	34 ALE-VABFES		
Mahogany		19 ALE-LSHH60MY	23 ALE-LS583020MY	27 ALE-LS593020MY	31 ALE-VA51-3622MY	35 ALE-VABFMY		
Medium Cherry		20 ALE-LSHH60MC	24 ALE-LS583020MC	28 ALE-LS593020MC	32 ALE-VA51-3622MC	36 ALE-VABFMC		
Modern Walnut		21 ALE-LSHH60WA	25 ALE-LS583020WA	29 ALE-LS593020WA	33 ALE-VA513622WA	37 ALE-VABFWA		
SIZE (W x D x H)		60" x 15" x 36½"	29½" x 19½" x 22½"	29½" x 19½" x 22½"	34" x 22¾" x 29½"	14¾" x 19½" x 22½"		
SHPG. WT.		104 lbs. ✖	95 lbs. 📦	71 lbs. ✖	149 lbs. 📦	55 lbs. ✖		
PRICE		399.00	399.00	349.00	500.00	299.00		
		Mobile File Pedestal with Full Length Pull	Seat Cushion	Core Removable Lock and Key Set	Polycarbonate Privacy Panel			
		Sturdy, all-metal construction. High-sided file drawer accommodates letter/legal filing. Accepts Alera® seat cushions.	Soft resilient foam covered in soft long-lasting fabric. Rubber grip bottom surface holds cushion in place without slipping; but easily repositionable.	Order one set per unit to key alike the workstation.	Divides workspaces, but allows light to pass through. Secure clip-on attachment; Fits Valencia Desk Shells only. Not freestanding. Silver.			
		ID	ID CRENDENZA SEAT CUSHION	ID	ID	ID		
Black		38 ALE-PBBFBL	41 ALE-PC3011	43 ALE-PC1511	45 ALE-VA50-1111	46 ALE-PP4718		
Charcoal		39 ALE-PBBFCH	42 ALE-PC3051	44 ALE-PC1551	1" w	47" x ½" x 18"		
Light Gray		40 ALE-PBBFLG			1 lb.	8 lbs.		
Smoke					20.00	11 lbs. 📦		
Tan Quartz						200.00		
SIZE (W x D x H)		147½" x 19½" x 21½"	29½" x 19½" x 2"	147½" x 19½" x 2"		65" x ½" x 18"		
SHPG. WT.		55 lbs.	31 lbs. 📦	18 lbs. 📦		11 lbs. 📦		
PRICE		349.00	99.00	79.00		200.00		

Preferred Settings

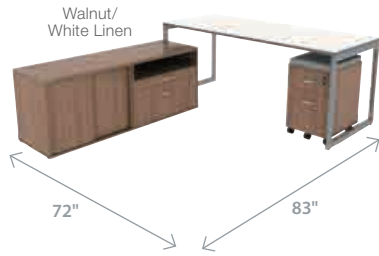
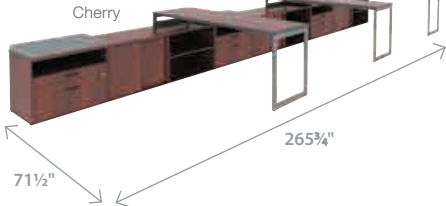
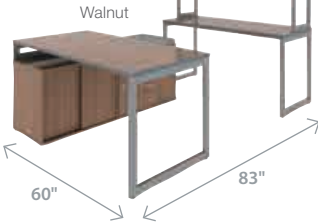

U-Workstation with Hutch 2,352.00

Qty.	Item No.	Description
1	ALE-LSHH60WA	60"W Hutch
1	ALE-TT6024EW	Reversible Table Top
1	ALE-TT6030EW	30" Adjustable O-Leg Desk Base
1	ALE-LSTB24GR	24" Adjustable O-Leg Desk Base
1	ALE-LS583020WA	Open Low File Cabinet
1	ALE-LSTB30GR	30" Adjustable O-Leg Desk Base
1	ALE-LS593020WA	Open Low Storage Cabinet
1	ALE-PC3051	Seat Cushion

Teaming Station with Storage 5,202.00

Qty.	Item No.	Description
3	ALE-TT7224CM	72"W x 24"D Reversible Table Top
6	ALE-LS583020MC	Open Low Storage Cabinet
3	ALE-LS583020MC	Open Low File Cabinet
3	ALE-LSTB24GR	24" Adjustable O-Leg Desk Base
3	ALE-PC3051	Seat Cushion

L-Workstation 1,664.00

Qty.	Item No.	Description
1	ALE-TT7224WG	72"W x 24"D Reversible Table Top
1	ALE-LS583020WA	Low File Credenza
1	ALE-LS593020WA	Open Low Storage Cabinet
1	ALE-VABFWA	Box/File Pedestal
1	ALE-LSTB24GR	24" Adjustable O-Leg Desk Base
1	ALE-PC1551	Seat Cushion

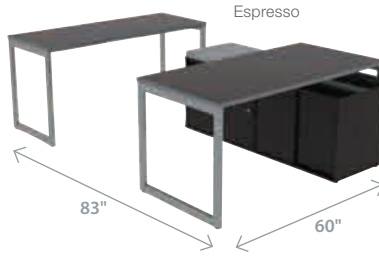
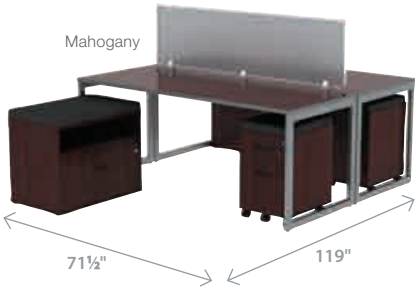

Two Person Workstation with Privacy Panel 3,188.00

Qty.	Item No.	Description
2	ALE-TT7230CM	72"W x 30"D Reversible Table Top
2	ALE-LS583020MY	Low File Credenza
2	ALE-VABFMY	Mobile Box/File Pedestal
1	ALE-PP6518	Privacy Panel
2	ALE-LSTB30GR	30" Adjustable O-Leg Desk Base
2	ALE-PC3011	Seat Cushion for Low Credenza
2	ALE-PC1511	Seat Cushion for File Pedestal

Desk and Credenza Workstation with Hutch 2,113.00

Qty.	Item No.	Description
1	ALE-LSHH60MY	60"W Hutch
1	ALE-LS583020MY	Low File Credenza
1	ALE-LS593020MY	Low Storage Cabinet Credenza
1	ALE-TT6030WG	60"W x 30"D Reversible Table Top
1	ALE-VABFMY	Mobile Box/File Pedestal
1	ALE-LSTB30GR	30" Adjustable O-Leg Desk Base
1	ALE-PC1551	Seat Cushion for File Pedestal

U-Workstation 1,953.00

Qty.	Item No.	Description
1	ALE-TT6024EW	60"W x 24"D Reversible Table Top
1	ALE-LS583020ES	Low File Cabinet Credenza
1	ALE-LS593020ES	Low Storage Cabinet Credenza
1	ALE-TT6030EW	60"W x 30"D Reversible Table Top
1	ALE-LSTB24GR	24" Deep Adjustable O-Leg Desk Base
1	ALE-LSTB30GR	30" Deep Adjustable O-Leg Desk Base
1	ALE-PC3051	Seat Cushion for Low Credenza

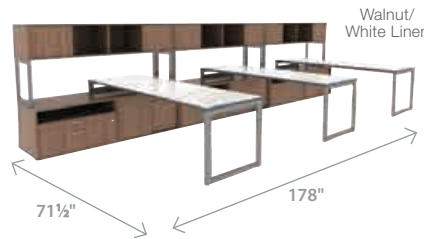

L-Workstation with Hutch 2,063.00

Qty.	Item No.	Description
1	ALE-TT7224WG	72"W x 24"D Reversible Table Top
1	ALE-LS583020ES	Low File Cabinet Credenza
1	ALE-LS593020ES	Low Storage Cabinet Credenza
1	ALE-LSHH60ES	60"W Hutch
1	ALE-VABFES	Mobile Box/File Pedestal
1	ALE-LSTB24GR	24" Deep Adjustable O-Leg Desk Base
1	ALE-PC1551	Seat Cushion for File Pedestal

L-workstation with Storage 1,843.00

Qty.	Item No.	Description
1	ALE-TT7230CM	72"W x 30"D Reversible Table Top
1	ALE-LS583020MY	Low File Cabinet Credenza
1	ALE-LS593020MY	Low Storage Cabinet Credenza
1	ALE-VABFMY	Mobile Box/File Pedestal
1	ALE-LSTB30GR	30" Deep Adjustable O-Leg Desk Base
1	ALE-PC1551	Seat Cushion for File Pedestal
1	ALE-PC3051	Seat Cushion for Low Credenza

Teaming Station with Hutch & Storage 5,295.00

Qty.	Item No.	Description
3	ALE-TT7230WG	72"W x 30"D Reversible Table Top
3	ALE-LS583020WA	Low File Cabinet Credenza
3	ALE-LS593020WA	Low Storage Cabinet Credenza
3	ALE-LSHH60WA	60"W Hutch
3	ALE-LSTB30GR	30" Deep Adjustable O-Leg Desk Base

17-AL-L-A3L



QAD Series

The perfect ready-to-go desk.



- Quick assembly with no-tools required.
- Get up and running in less than 5 minutes.
- Built-in modesty panel with punched metal holes for a clean modern look.
- Ideally sized for the small office or anyplace where space is tight.
- Thermally fused laminate top is scratch-, dent- and water-resistant.
- Adjustable leveling glides compensate for uneven floors.
- Meets or exceeds ANSI/BIFMA Standards.



QAD Series

Quick Assemble Desk

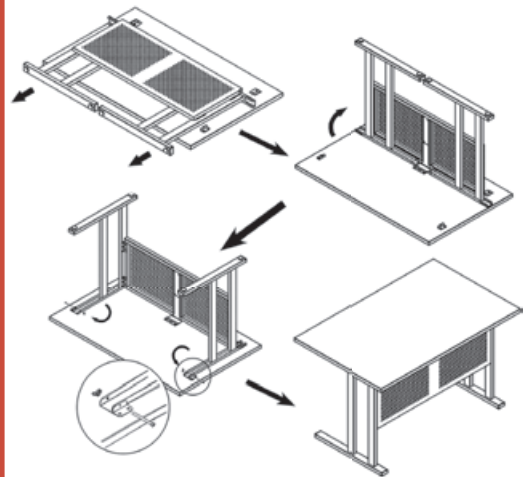

Desk assembles in minutes without tools!

ID	1	ALE-QAD4830MY
Mahogany/Black		
SIZE (W x D x H)	48"	30" x 29"
SHPG. WT.	86 lbs.	
PRICE	455.00	



new

Valencia Series

Mobile Workstation desk.



- Scaled to fit in tight spaces, and designed so it can pass through standard doorways to go from room to room.
- Full width, full-extension slide-out keyboard tray.
- Grommet for cable and wire management.
- Undermount interior shelf for quick storage and to hold wires when moving.
- Three-fourths height back modesty panel for privacy.
- Four casters (two locking) for mobility.

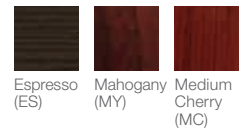

Valencia Series

Mobile Workstation Desk

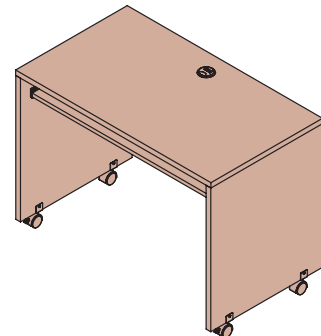

ID	2	ALE-VA204224ES
Espresso		
Mahogany	3	ALE-VA204224MY
Medium Cherry	4	ALE-VA204224MC
SIZE (W x D x H)	41 $\frac{3}{8}$ "	25 $\frac{1}{2}$ " x 29 $\frac{1}{2}$ "
SHPG. WT.	99 lbs.	
PRICE	275.00	



Steel Desks

Durable woodgrain laminate top is scratch-resistant.



- Powder coated steel frame.
- Features aluminum drawer handles and chrome-plated 1" sq. tubular steel legs with adjustable levelers.
- Central locking system for all drawers.
- Minimal assembly, just attach legs.
- Manufacturer's limited five-year warranty.
- Contains 17% post-consumer recycled content, 48% total recycled content.
- Meets or exceeds ANSI/BIFMA Standards.



See more Alera products at www.aleradetails.com



Selection Guide For Steel Desks

	Double Pedestal Steel Desk	Single Pedestal Steel Desk	Double Pedestal Steel Credenza
	Full extension locking file drawers accommodate hanging file folders. Box drawers are equipped with dividers. Center drawer with supply tray.	Full extension locking file drawer accommodates hanging file folders. Box drawer is equipped with dividers. Center drawer with supply tray.	Full extension file drawer accommodates hanging file folders. Box drawer is equipped with dividers. Not locking.
	ID 72"	ID 60"	ID 24" DEEP
	1 ALE-SD7236PC	3 ALE-SD6030PC	7 ALE-SD6024PC
	2 ALE-SD7236BW	4 ALE-SD6030BW	8 ALE-SD6024BW
	72" x 36" x 29½"	60" x 30" x 29½"	60" x 24" x 29½"
	203 lbs.	198 lbs.	160 lbs.
	PRICE 1,339.00	719.00	1,109.00

17-AL-L-A3L

Computer Furniture

Bring technology, efficiency and comfort together.



Indispensable in today's tech-centered world, these pieces offer the perfect solution to long hours working with a computer. Excellent ergonomics are the key and our sit-stand designs deliver, adapting to comfortable heights and encouraging healthy movement. From machine stands to workstations, our computer furniture offers flexibility, organization, even mobility, so you can work smarter in the digital age.

Height-Adjustable Tables	17
Workstations	18
Anti-Fatigue Mat	19
Monitor Arms	19
Stools	20



Height-Adjustable Table Base Series

Flexible, productive, ergonomic. These height-adjustable tables allow the user to move from sitting to standing with one touch.

- A great solution to retro-fit existing worksurfaces and add ergonomics to the office infrastructure.
- Solutions for every size, budget and requirement with electric or pneumatic controls.
- Bases accept most common sized worksurfaces.
- Strong powder coated steel frame with cross bars provides stability and prevents racking.
- Adjustable leveling glides to compensate for uneven floors.
- Manufacturer's limited five-year warranty.
- Meets or exceeds ANSI/BIFMA Standards; UL Listed.

Top and Base sold and shipped separately—ORDER BOTH.

A THREE-STAGE ELECTRIC HEIGHT-ADJUSTABLE TABLE BASE WITH MEMORY CONTROLS

Four-memory presets and up and down controls. Quick setup with fold-out legs requires minimal assembly. Durable base with 275-lb. lift capacity moves within a 25¾" range from 25" to 50¾" (not including worksurface). Attaches to most common worksurfaces ranging from 47" to 75" width; and 24" to 36" depth. Integrated cable management channels; includes 6.5 ft power cord. Dual motors with movement up to 1.5 inches per second depending on load. Accepts optional casters for mobility.

ID No.	Height	Color	Shpg. Wt.	Unit	Price
1 ALE-HT3SAB	25" - 50¾"	Black	84 lbs.	Each	1,149.00
2 ALE-HT3SAG	25" - 50¾"	Gray	84 lbs.	Each	1,149.00

B TWO-STAGE ELECTRIC HEIGHT-ADJUSTABLE TABLE BASE

Standard up and down controls. Quick setup with fold-out legs requires minimal assembly. Durable base with 250-lb. lift capacity moves within a 20" range from 27¼" to 47¼" (not including worksurface). Attaches to most common worksurfaces ranging from 47" to 75" width; and 24" to 36" depth. Integrated cable management channels; includes 6.5 ft power cord. Dual motors with movement up to 1.2 inches per second depending on load. Accepts optional casters for mobility.

ID No.	Height	Color	Shpg. Wt.	Unit	Price
3 ALE-HT2SSB	27¼" - 47¼"	Black	79 lbs.	Each	999.00
4 ALE-HT2SSG	27¼" - 47¼"	Gray	79 lbs.	Each	999.00

C THREE-STAGE SINGLE-COLUMN ELECTRIC HEIGHT-ADJUSTABLE TABLE BASE

Three-stage single-column telescoping height-adjustable base with standard up and down controls. Durable steel base with 125-lb lifting capacity moves within a 19" range from 24½" to 43¾" (not including worksurface). Attaches to most common worksurfaces ranging from 30" to 42" width; and 12" to 27½" depth. Integrated cable management channels; includes 6.5 ft power cord. Single motor with movement up to 1.2 inches per second depending on load. Accepts optional casters for mobility.

ID No.	Height	Color	Shpg. Wt.	Unit	Price
5 ALE-HT1CSB	24½" - 43¾"	Black	55 lbs.	Each	799.00
6 ALE-HT1CSG	24½" - 43¾"	Gray	55 lbs.	Each	799.00

D PNEUMATIC HEIGHT-ADJUSTABLE TABLE BASE

Pneumatic control lift-assist height-adjustable table base. No electricity needed. Durable base recommended for up to 100-lb. lift capacity including weight of worksurface. Movement within a 13" range from 26¾" to 39¾". Accommodates most common worksurfaces ranging from 59" to 72" width; and 24" to 30" depth. Accepts optional casters for mobility.

ID No.	Height	Color	Shpg. Wt.	Unit	Price
7 ALE-HTPN1B	26¾" - 39¾"	Black	62 lbs.	Each	759.00
8 ALE-HTPN1G	26¾" - 39¾"	Gray	62 lbs.	Each	749.00

E CASTERS FOR HEIGHT-ADJUSTABLE TABLE BASES

Move and reposition your Alera® Height-Adjustable Table Bases with these convenient casters. Easy to attach. Four casters (2 locking).

ID No.	Unit	Price
9 ALE-HT3004	4/Set	49.00

Reversible Laminate Table Top

Take your pick. Multiple sizes and colors to create your own unique desk, table or workstation.

- Reversible table tops have a different color and pattern on each side with coordinating dark gray edge banding.
- Use with Alera® bases to create height adjustable workstations, training tables, collaborative spaces or standard desks.
- Durable laminate is water-, scratch-, and dent-resistant.
- Coordinating colors with Alera® Valencia and Sedina Office Suites.
- Commercial grade, 1" thick top.
- Manufacturer's limited five-year warranty.
- Meets or exceeds ANSI/BIFMA Standards.

Top and Base sold and shipped separately—ORDER BOTH.

F REVERSIBLE LAMINATE TABLE TOPS

ID No.	Color	W × D	Shpg. Wt.	Unit	Price
10 ALE-TT7230EW	Espresso/Walnut	71½" × 29½"	62 lbs.	Each	219.00
11 ALE-TT7230CM	Medium Cherry/Mahogany	71½" × 29½"	62 lbs.	Each	219.00
12 ALE-TT7230WG	White/Gray	71½" × 29½"	62 lbs.	Each	219.00
13 ALE-TT7224EW	Espresso/Walnut	71½" × 23¾"	51 lbs.	Each	159.00
14 ALE-TT7224CM	Medium Cherry/Mahogany	71½" × 23¾"	51 lbs.	Each	159.00
15 ALE-TT7224WG	White/Gray	71½" × 23¾"	51 lbs.	Each	159.00
16 ALE-TT6030EW	Espresso/Walnut	59½" × 29½"	52 lbs.	Each	189.00
17 ALE-TT6030CM	Medium Cherry/Mahogany	59½" × 29½"	52 lbs.	Each	189.00
18 ALE-TT6030WG	White/Gray	59½" × 29½"	52 lbs.	Each	189.00
19 ALE-TT6024EW	Espresso/Walnut	59½" × 23¾"	43 lbs.	Each	139.00
20 ALE-TT6024CM	Medium Cherry/Mahogany	59½" × 23¾"	43 lbs.	Each	139.00
21 ALE-TT6024WG	White/Gray	59½" × 23¾"	43 lbs.	Each	139.00
22 ALE-TT4824EW	Espresso/Walnut	47¾" × 23¾"	36 lbs.	Each	119.00
23 ALE-TT4824CM	Medium Cherry/Mahogany	47¾" × 23¾"	36 lbs.	Each	119.00
24 ALE-TT4824WG	White/Gray	47¾" × 23¾"	36 lbs.	Each	119.00
25 ALE-TT3624EW	Espresso/Walnut	35¾" × 23¾"	28 lbs.	Each	89.00
26 ALE-TT3624CM	Medium Cherry/Mahogany	35¾" × 23¾"	28 lbs.	Each	89.00
27 ALE-TT3624WG	White/Gray	35¾" × 23¾"	28 lbs.	Each	89.00

Prices subject to change without notice.

Visit our website for the latest pricing and product information.

Computer Furniture Sit-To-Stand



A

new

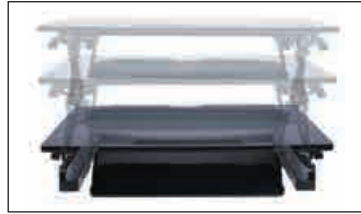

new



A



B

new

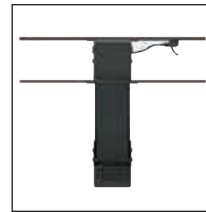

A SIT-STAND LIFTING WORKSTATION



These lifting workstations turn any desk into an ergonomic sit-stand station. Raise and lower with ease within a 14" range by simply pressing the levers on each side to engage. Two-tiered worksurface and keyboard/mouse platform for better ergonomics. Platform's rear-notched design accommodates most monitor arms and cable management. Designed for use with Alera® Monitor Arms. Smart space-saving design stays within your desk space and raises vertically within the same plane. No having to step back and out when in the raised position. Reinforced base for stability at any height. Will not flip or height-drop even when leaning on the workstation. Includes slot to hold tablets and phones. Manufacturer's limited five-year warranty. Meets or exceeds ANSI/BIFMA Standards. 

ID No.	Worksurface Dimensions	Total Weight Capacity	Shpg. Wt.	Unit	Price
1 ALE-AEWR2B	35½" × 23¾"	35 lbs.	49 lbs.	Each	629.00
2 ALE-AEWR1B	26¾" × 23¼"	35 lbs.	44 lbs.	Each	549.00

B SIT-STAND WORKSTATION

Allows users to stay active while staying productive. Height adjustment is quick and effortless with the help of a heavy-duty gas-assist cylinder with adjustable tension and infinite positive stop. The beveled, seamless worksurface supports up to two 24" monitors while still providing room for other work materials. This model provides 16" of height adjustment and can mount on most worksurfaces 20"-30" deep. Pair with the Alera® monitor arms for additional functionality. Manufacturer's limited five-year warranty. Meets or exceeds ISTA Standards. 

ID No.	W × D × H	Total Wt. Cap.	Lift	Shpg. Wt.	Unit	Price
3 ALE-AEWR5B	31½" × 40" × 20"	28 lbs.	16"	60 lbs.	Each	509.00



A

A - D
new



B



C



D



A ANTI-FATIGUE MAT

Encourages proper ergonomics and reduces fatigue with this cushioned standing mat. Beveled edge lays flat on the floor to reduce trip hazards. Rubber and vinyl construction ensures long lasting resiliency and cushioning. Ideal for use at sit-to-stand workstations, service counters, breakrooms, or where ever standing is required. Easy to clean surface with molded grid pattern to catch dirt and spills. Combine with Alera® Height Adjustable Tables or Alera® Lifting desks for even more ergonomic benefits with your sit-to-stand workstations. Manufacturer's limited five-year warranty.

ID No.	Color	W x L	Qty.	Unit	Price
1 ALE-AE23AFM	Black	24" x 36"	1	Each	99.00

Monitor Arms

Strong durable construction withstand the rigors of the busy office.

- Easy to install clamp or grommet mounting fits desk up to 4" thick and grommets up to 2 3/4" in diameter.
- Saves valuable desk space.
- Highly adjustable arm moves smoothly up or down, in or out, tilt, or rotate with ease.
- Manufacturer's limited five-year warranty.
- Use with Alera® Sit-Stand Lifting Workstations.
- VESA MIS-D Compliant.

B HEAVY-DUTY ARTICULATING MONITOR ARM WITH USB

ID No.	For Monitors (Size, Weight)	Unit	Price
Single Monitor —Also includes 2 USB ports.			
2 ALE-AEMA1H	Up to 32", up to 25 lbs.	Each	219.00
Dual Monitors —Also includes 2 USB and audio ports.			
3 ALE-AEMA2H	Up to 32", up to 25 lbs. per arm.	Each	399.00

C ARTICULATING MONITOR ARM

ID No.	For Monitors (Size, Weight)	Unit	Price
Single Monitor			
4 ALE-AEMA1L	Up to 27", up to 15 lbs.	Each	199.00
Dual Monitors			
5 ALE-AEMA2L	Up to 27", up to 15 lbs. per arm.	Each	349.00

D POLE-MOUNTED MONITOR ARM

Not grommet mountable.

ID No.	For Monitors (Size, Weight)	Unit	Price
Single Monitor			
6 ALE-AEMA1B	Up to 30", up to 25 lbs.	Each	139.00
Dual Monitors			
7 ALE-AEMA2B	Up to 30", up to 25 lbs. per arm.	Each	249.00

Prices subject to change without notice.
Visit our website for the latest pricing and product information.

Computer Furniture Sit-To-Stand



Sit-to-Stand Perch Stool



Gray (GR) Blue (BU) Black (BK)

Balance Perch Stool



Red (RD) Blue (BU) Black (BK)



Perch Series

Advanced active ergonomics goes from sitting to standing with ease.

- Pivoting angled column moves with the body for constant alignment.
- Great for perching for fast tasks or lean back and sit for more intensive focused work.
- Goes from sitting height to standing height.
- Auto return swivel seat moves with the body as you twist, and returns to front automatically when you get up.
- Wide boomerang base for stability when leaning far forward.
- Manufacturer's limited five-year warranty.
- Meets or exceeds ANSI/BIFMA Standards.



ID No.	Color	Shpg. Wt.	Unit	Price
--------	-------	-----------	------	-------

A SIT-TO-STAND PERCH STOOL

Supports up to 250 lbs. Seat: 14 $\frac{1}{4}$ " x 13 $\frac{3}{4}$ ". Overall height: 24 $\frac{3}{4}$ " to 33 $\frac{7}{8}$ ".

Black Base

1	ALE-AE35PSBK	Black	18 lbs.	Each	299.00
2	ALE-AE35PSBU	Blue	18 lbs.	Each	299.00
3	ALE-AE35PSGR	Gray	18 lbs.	Each	299.00

Silver Base

4	ALE-AE36PSBK	Black	18 lbs.	Each	299.00
5	ALE-AE36PSBU	Blue	18 lbs.	Each	299.00
6	ALE-AE36PSGR	Gray	18 lbs.	Each	299.00

Balance Perch Stool

Lightweight, mobile frame is easy to move.

- Waterfall seat edge increases ergonomic comfort.
- Simple one-touch height adjustment.
- Full 360-degree range of motion.
- Extra wide handle provides a confident grip.
- Manufacturer's limited five-year warranty.
- Meets or exceeds ISTA Standards.

ID No.	Color	Shpg. Wt.	Unit	Price
--------	-------	-----------	------	-------

B BALANCE PERCH STOOL

Supports up to 250 lbs. Overall height: 22 $\frac{1}{2}$ " to 33 $\frac{7}{8}$ ".

Black Base

7	ALE-AE33PSBK	Black	20 lbs.	Each	349.00
8	ALE-AE33PSBU	Blue	20 lbs.	Each	349.00
9	ALE-AE33PSRD	Red	20 lbs.	Each	349.00

White Base

10	ALE-AE34PSBK	Black	20 lbs.	Each	349.00
11	ALE-AE34PSBU	Blue	20 lbs.	Each	349.00
12	ALE-AE34PSRD	Red	20 lbs.	Each	349.00

Perch Sit Stool Series

Comfortable, stylish and adjustable.

- Push comfortable seat with tilt feature allows user to perch in a dynamic work position.
- Seat height range suitable for adjustable workbench, desk and counter applications.
- Ready to reach handles for hassle free adjustment.
- Built in handle for portability.
- Round steel base provides reliable and firm support.
- Manufacturer's limited five-year warranty.
- Meets or exceeds ANSI/BIFMA Standards.

ID No.	Color	Shpg. Wt.	Unit	Price
--------	-------	-----------	------	-------

C PERCH SIT STOOL

Supports up to 250 lbs. Seat: 14" x 14". Overall height: 25 $\frac{1}{4}$ " to 35 $\frac{1}{2}$ ".

13	AAP-SQ600	Black	22 lbs.	Each	199.99
----	-----------	-------	---------	------	--------



Lean-In Sit/Stand Stool Series

Innovative, interactive and comfortable.

- Inclined lift position allows for dynamic postures needed for various tasks.
- Push generously sized seat allows maximum comfort.
- Ready to reach handles for hassle free adjustment.
- Arc shaped steel frame provides superior strength and support.
- Built-in rollers assure easy portability.
- Manufacturer's limited five-year warranty.
- Meets or exceeds ANSI/BIFMA Standards.

ID No.	Color	Shpg. Wt.	Unit	Price
--------	-------	-----------	------	-------

D LEAN-IN SIT/STAND STOOL

Supports up to 250 lbs. Seat: 15 $\frac{3}{4}$ " x 12". Overall height: 24" to 33".

14	AAP-ST601	Black	22 lbs.	Each	399.99
----	-----------	-------	---------	------	--------

SS Series

Designed to deliver the comfort of sitting even when standing.

- Seat adjusts to accommodate perch positioning.
- Tear/poke resistant and wipe-friendly seat facilitates easy maintenance.
- Non-marring rubber padded base assures stability.
- Manufacturer's limited five-year warranty.
- Meets or exceeds ANSI/BIFMA Standards.

ID No.	Color	Shpg. Wt.	Unit	Price
--------	-------	-----------	------	-------

E SIT/STAND ADJUSTABLE STOOL

Supports up to 300 lbs. Seat: 14" x 8 $\frac{1}{2}$ ". 23 $\frac{1}{2}$ " to 33 $\frac{1}{2}$ ".

15	AAP-SS600	Black	26 lbs.	Each	399.00
----	-----------	-------	---------	------	--------



For more information on additional chair features see page 22.

Pneumatic Seat Height Adjustment

Seating

Get comfortable anywhere, any time.



Just right chairs for everywhere—today's flexible workspaces require a variety of seating and you'll find them all here: welcoming styles for reception areas; supportive, adaptable designs for long hours at a desk; and nesting, stacking and folding styles great for collaborative areas that need to morph in a matter of minutes. So sit back and relax, we've got your seating solution covered.

Reception Room	23-28
Leather & Vinyl	30-37
Mesh	38-46
Office	47-49
Big & Tall	50-52
Stacking/Nesting/Folding	53-55
Stools	56-59
Footrests & Back Supports	62

Buying Guide Chair Features

Find the functions you're looking for using the following icons shown throughout the seating section.



Pneumatic Seat Height Adjustment

Regulates seat height relative to the floor so that feet are flat on the floor—supports better circulation.



Back Height Adjustment

Positions height of lumbar support relative to the seat cushion to alleviate back stress.



Seat Glide Mechanism

Seat or back moves forward or back, then locks in position to create the proper seat depth for better back support and circulation to legs.



Tilt Tension/Tilt Lock

Tilt allows back to recline at a 1:1 ratio to seat for a comfortable reclining position and redistribution of pressure points. Tilt tension controls the rate and ease at which the chair reclines and the lock-out tilt function keeps chair in upright position.

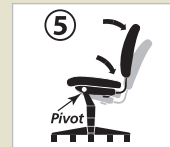

Knee Tilt

Pivot point located below front half of seat. Allows user to keep feet flat on floor while reclining. Offers increased circulation and redistribution of pressure points.



Synchronized Knee Tilt

Combines, at a 2:1 ratio, the smooth recline of the back with the limited front rise of the seat to keep feet on the floor and improve circulation to legs.



Dual-Action Tilt

Back reclines at a 2:1 ratio to seat angle creating relaxed positions while keeping feet relatively flat on the floor.



Posture Lock

Holds back in place in an infinite number of positions within a fixed range to offer variety in spinal alignment and weight distribution.



Multi-Task Control

Single lever easily adjusts seat and back angles independently, providing an infinite number of locking positions within a fixed range for customized comfort.



Asynchronous Control

Three levers modify: angle of back relative to seat; tilt (free float or locking); and forward tilt. Offers a wide variety of movement, spinal alignment and weight distribution.



Dual-Clutch Posture Control

Seat and back angles adjust independently and lock in infinite positions within a fixed range—ideal for quick adaptation to different activities and multiple users.

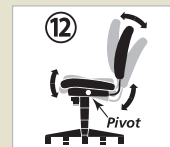

Variable Synchro-Tilt

Back reclines in a 2:1 ratio to seat angle. Chair tilts freely, locks in five positions, or tilts forward to alleviate pressure points.



Integral Lumbar Support

Lumbar support within the chair back is height adjustable for proper placement; alleviates back stress.





Black (S10B)



Black (S10B)



Mahogany (MY)



Mahogany (MY)

Upholstery Reception Lounge Series



Black (S10B)

Finishes Valencia Series



Black (BK)



Mahogany (MY)



Medium Cherry (MC)



Reception Lounge Sofa Series

Classic simple lines, for use in any reception or lounge configurations.

- Richly cushioned seats and back, for comfort.
- Fully assembled; just attach legs.
- Soft black leather with black wood pyramid legs.
- Leveling glides for stability.
- Manufacturer's limited five-year warranty.
- Meets or exceeds ANSI/BIFMA standards.



Valencia™ Series Occasional Tables



Simple classic design blends seamlessly into any decor.

- Durable woodgrain laminate is water-, scratch- and dent-resistant featuring 3 mm protective edge banding.
- Leveling glides to compensate for uneven floors.
- Easy to assemble, just add legs.
- Manufacturer's limited five-year warranty.
- Meets or exceeds ANSI/BIFMA standards.

ID No.	Finish/Color	W × D × H	Shpg. Wt.	Unit	Price
A SOFA					
1	ALE-RL21LS10B	Black	77" × 31½" × 32"	95 lbs.	Each 1,299.00
B LOVE SEAT					
2	ALE-RL22LS10B	Black	55½" × 31½" × 32"	75 lbs.	Each 969.00
C CLUB CHAIR					
3	ALE-RL23LS10B	Black	35" × 31½" × 32"	58 lbs.	Each 689.00

ID No.	Color	W × D × H	Shpg. Wt.	Unit	Price
D COFFEE TABLE					
4	ALE-VA7548BK	Black	47¼" × 20" × 16¾"	42 lbs.	Each 199.00
5	ALE-VA7548MY	Mahogany	47¼" × 20" × 16¾"	42 lbs.	Each 199.00
6	ALE-VA7548MC	Medium Cherry	47¼" × 20" × 16¾"	42 lbs.	Each 199.00
E CORNER TABLE					
7	ALE-VA7524BK	Black	23¾" × 23¾" × 20¾"	32 lbs.	Each 150.00
8	ALE-VA7524MY	Mahogany	23¾" × 23¾" × 20¾"	32 lbs.	Each 150.00
9	ALE-VA7524MC	Medium Cherry	23¾" × 23¾" × 20¾"	32 lbs.	Each 150.00
F END TABLE					
10	ALE-VA7520BK	Black	23¾" × 20" × 20¾"	28 lbs.	Each 140.00
11	ALE-VA7520MY	Mahogany	23¾" × 20" × 20¾"	28 lbs.	Each 140.00
12	ALE-VA7520MC	Medium Cherry	23¾" × 20" × 20¾"	28 lbs.	Each 140.00

Prices subject to change without notice.
Visit our website for the latest pricing and product information.



See more Alera products at www.aleradetails.com



QUB Series

Contemporary geometric reception room sectional set can be configured in endless possibilities.

- Tufted seat design with straight backs and arms for a modern yet comfortable look.
- Silver steel frames and legs adds style.
- Manufacturer's limited five-year warranty.
- Contains 5% post-consumer recycled content, 35% total recycled content.
- Meets or exceeds ANSI/BIFMA standards.



ID No.	Color	W x D x H	Shpg. Wt.	Unit	Price
--------	-------	-----------	-----------	------	-------

A CORNER SECTIONAL

Corner sectional can be configured with armless sectional and ottoman.

1	ALE-QB8016	Black	26¾" x 26¾" x 30½"	58 lbs.	Each	455.00
---	------------	-------	--------------------	---------	------	--------

B ARMLESS L SECTIONAL

Armless sectional can be configured with corner sectional and ottoman.

2	ALE-QB8116	Black	26¾" x 26¾" x 30½"	41 lbs.	Each	405.00
---	------------	-------	--------------------	---------	------	--------

Powered—1 outlet and 2 USB ports.

3	ALE-QB8116P	Black	26¾" x 26¾" x 30½"	41 lbs.	Each	455.00
---	-------------	-------	--------------------	---------	------	--------

C OTTOMAN

Ottoman can be configured with corner and armless sectional. Can be placed to create two-sided seating with armless sectional when placed back-to-back.

4	ALE-QB8216	Black	26¾" x 21½" x 17½"	29 lbs.	Each	355.00
---	------------	-------	--------------------	---------	------	--------

D POWERED ARMREST WEDGE

Easily add an armrest with power by wedging between armless sectional, corner sectional or ottoman. Conveniently powered with an electrical outlet and two USB ports to charge up any device.

5	ALE-QB8316	Black	5¾" x 26¾" x 30½"	15 lbs.	Each	219.00
---	------------	-------	-------------------	---------	------	--------

Round Occasional Table

Modern occasional tables to create the perfect accent in any décor.

- Round laminate tops seem to float on the silver metal base.
- Durable woodgrain laminate top is water-, scratch-, and dent-resistant.
- Includes pads to keep floors scratch free.
- Manufacturer's limited five-year warranty.
- Meets or exceeds ANSI/BIFMA standards.



ID No.	Color	Size	Shpg. Wt.	Unit	Price
--------	-------	------	-----------	------	-------

E COFFEE TABLE

6	ALE-CT7730B	Black	29¾" dia x 15½" h	28 lbs.	Each	250.00
---	-------------	-------	-------------------	---------	------	--------

F CORNER TABLE

7	ALE-CT7721B	Black	21¼" dia x 22¾" h	19 lbs.	Each	200.00
---	-------------	-------	-------------------	---------	------	--------



A



B



C

Reception Lounge
500 Series



D

new



E

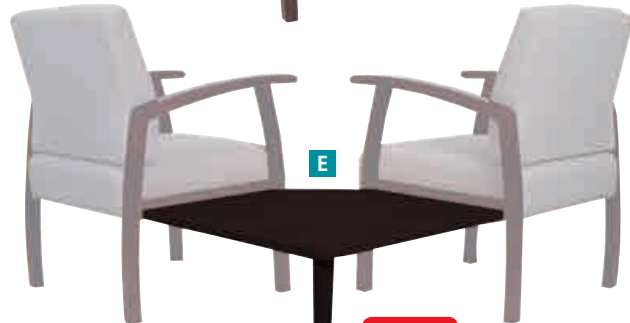

new

D



Reception Lounge
700 Series



Sandstone

E



Reception Lounge 700 Series



Reception Lounge 500 Series

Handsome, handcrafted hardwood seating.

- Statement seating for the executive office or reception rooms.
- Rich glossy mahogany for a fine finish.
- Cushioned leather upholstery for both comfort and style.
- Manufacturer's limited five-year warranty.
- Meets or exceeds ANSI/BIFMA Standards.

Comfortably sized reception chairs and tables are easily configurable to fit any waiting room.

- Stylish wood finish, durable fabric, and enhanced padding makes your guests feel right at home.
- Sturdy ganging coffee tables fit between chairs or corners.
- Leveling glides help compensate for uneven floors.
- Manufacturer's limited five-year warranty.
- Meets or exceeds ANSI/BIFMA Standards.

ID No.	Color	Shpg. Wt.	Unit	Price
A HALF BACK WOOD GUEST CHAIR				
Fully cushioned half-back adds a sense of openness and space. Supports up to 250 lbs. Seat: 20 $\frac{1}{8}$ " × 17 $\frac{1}{2}$ ". Back: 20 $\frac{1}{8}$ " × 31 $\frac{1}{8}$ ". Overall height: 31 $\frac{1}{8}$ ".				
1	ALE-RL5319M	Black	32 lbs.	Each 429.00
B ARCH BACK SOLID WOOD CHAIR				
Classic full arched back design with leather upholstery front and back. Supports up to 250 lbs. Seat: 22" × 17 $\frac{1}{2}$ ". Back: 18 $\frac{1}{2}$ " × 14 $\frac{1}{2}$ ". Overall height: 32 $\frac{1}{2}$ ".				
2	ALE-RL5219M	Black	27 lbs.	Each 429.00
C ARCH BACK CUT-OUT WOOD GUEST CHAIR				
Stylish arch back design with cut-outs. Supports up to 250 lbs. Seat: 20 $\frac{1}{8}$ " × 17 $\frac{1}{2}$ ". Back: 18 $\frac{1}{2}$ " × 33 $\frac{1}{8}$ ". Overall height: 33 $\frac{1}{8}$ ".				
3	ALE-RL5119M	Black	34 lbs.	Each 459.00

ID No.	Color	W × D	Shpg. Wt.	Unit	Price
D GUEST CHAIR					
Supports up to 250 lbs. Seat: 21 $\frac{1}{8}$ " × 24 $\frac{1}{2}$ ". Back: 21 $\frac{1}{8}$ " × 17 $\frac{1}{2}$ ". Overall height: 35".					
4	ALE-RL7611M	Black/Mahogany	27 lbs.	Each	349.00
5	ALE-RL7651M	Sandstone/Mahogany	27 lbs.	Each	349.00
E GANGING TABLES					
Reinforced brackets with multiple connection points for a solid tabletop. Durable woodgrain laminate is water-, scratch-, and dent-resistant.					
Bridge Table —Creates a coffee table between two chairs horizontally.					
6	ALE-RL7619M	Mahogany	18 $\frac{1}{2}$ " × 21 $\frac{1}{2}$ "	11 lbs.	Each 69.00
Corner Table —Creates a coffee table between two chairs in a corner; includes corner support leg.					
7	ALE-RL7628M	Mahogany	27 $\frac{1}{2}$ " × 27 $\frac{1}{2}$ "	20 lbs.	Each 99.00

Prices subject to change without notice.
Visit our website for the latest pricing and product information.

Seating Reception Room



Black/
Mahogany

A



Tan/
Mahogany

C



Black
(11)

E



Black/
Mahogany

B



Graphite
(FC40)

D

WL Series

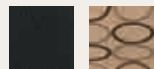

Black

Tan



Mahogany

Espresso

Genaro High-Back Guest Chair



Black
(LS10)

Graphite
(FC40)

Genaro Sled Base Guest Chair



Vinyl
(16)

Fabric
(11)



Reception Lounge WL Series

Configure with sofas and tables to create reception, lounge, conference, and waiting rooms.

- An economical choice for reception seating.
- Strong wood frame structure with fabric or leather upholstery.
- Leveling glides help compensate for uneven floors.
- Manufacturer's limited five-year warranty.
- Contains 5% post-consumer recycled content, 30% total recycled content.
- Meets or exceeds ANSI/BIFMA Standards.

ID No. Finish/Color W x D x H Shpg. Wt. Unit Price

A LOVESEAT

An economical choice for reception seating. Mahogany wood frame with soft leather upholstery. Supports up to 500 lbs.

1 ALE-RL2219M Black/Mahogany 44 $\frac{1}{2}$ " x 26 $\frac{1}{2}$ " x 33" 53 lbs. Each 579.00

B THREE-SEATER BENCH

Mahogany wood frame with soft leather upholstery. Richly padded and generously sized seating surface. Great to help divide seating areas. Supports up to 750 lbs.

2 ALE-RL2419M Black/Mahogany 65 $\frac{3}{4}$ " x 22 $\frac{1}{4}$ " x 22 $\frac{7}{8}$ " 60 lbs. Each 559.00

C WOOD GUEST CHAIR

Wood frame with fabric or soft leather upholstery. Leveling glides for stability. Supports up to 250 lbs. Seat: 20 $\frac{3}{4}$ " x 20 $\frac{3}{4}$ ". Back: 20 $\frac{3}{4}$ " x 17 $\frac{3}{4}$ ". Overall height: 33 $\frac{1}{4}$ ".

Leather

3 ALE-RL4319C Black/Cherry 29 lbs. Each 309.00

4 ALE-RL4319E Black/Espresso 29 lbs. Each 309.00

5 ALE-RL4319M Black/Mahogany 29 lbs. Each 309.00

Fabric

6 ALE-RL4351M Tan/Mahogany 29 lbs. Each 309.00

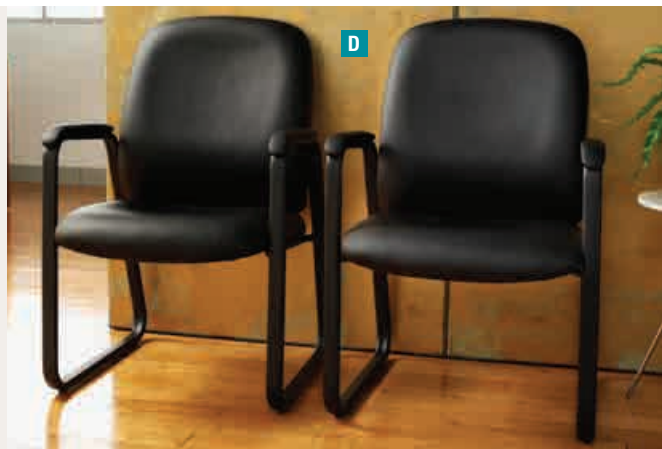

D

Genaro Series

Clean, classic lines complement any office environment.

- Configure to create reception, lounge, conference, and waiting rooms.
- Thickly padded for maximum comfort.
- Durable upholstery withstands everyday use.
- Padded armrests for soft support.
- Sturdy black steel sled base.
- Manufacturer's limited five-year warranty.
- Meets or exceeds ANSI/BIFMA Standards.

ID No. Color Shpg. Wt. Unit Price

D HIGH-BACK GUEST CHAIR

Supports up to 250 lbs. Seat: 21 $\frac{1}{2}$ " x 20 $\frac{1}{2}$ ". Back: 20 $\frac{1}{2}$ " x 21 $\frac{1}{2}$ ". Overall height: 36 $\frac{1}{2}$ ".

Leather

7 ALE-GE43LS10B Black 35 lbs. Each 325.00

Fabric

8 ALE-GE43FC40B Graphite 35 lbs. Each 345.00

E SLED BASE GUEST CHAIR

Supports up to 250 lbs. Seat: 20 $\frac{1}{2}$ " x 19 $\frac{1}{4}$ ". Back: 19 $\frac{3}{4}$ " x 17". Overall height: 34".

Faux Leather

9 ALE-RL43C16 Black 30 lbs. Each 209.00

Fabric

10 ALE-RL43C11 Black 30 lbs. Each 209.00



Ispara Series

Contemporary geometric styling in soft durable leather.

- Configure your reception area or waiting room with these chairs and ottomans.
- Modular pieces fit even the most difficult layouts.
- Heavy duty silver steel structure withstands constant use and movement.
- Leveling glides for stability.
- Manufacturer's limited five-year warranty.
- Meets or exceeds ANSI/BIFMA Standards.

ID No.	Finish/Color	W x D x H	Shpg. Wt.	Unit	Price	
A ARMLESS CUBE CHAIR						
1	ALE-RL8319CS	Black/Silver	26 $\frac{1}{2}$ " x 31 $\frac{1}{2}$ " x 30"	37 lbs.	Each	329.00
B CUBE OTTOMAN						
2	ALE-RL8319CSM	Black/Silver	26 $\frac{1}{2}$ " x 22 $\frac{1}{2}$ " x 17 $\frac{1}{2}$ "	21 lbs.	Each	229.00



new



metaLounge Series

Stylish and flexible design for your high-traffic areas.

- Ideal for entryway, reception, and waiting rooms.
- Metal guest chair is easy to maintain and clean with anti-microbial upholstery and clean-out gap.
- Strong metal frame withstands heavy use.
- Wall-saver legs flair out to protect walls from accidental bumps.
- Polyurethane arms are both comfortable and long-lasting.
- Waterfall seat design relieves pressure points at the back of the knees.
- Manufacturer's limited five-year warranty.
- Contains 5% post-consumer recycled content, 30% total recycled content.
- Meets or exceeds ANSI/BIFMA Standards.

ID No.	Color	W x D x H	Shpg. Wt.	Unit	Price	
C GUEST CHAIR						
3	ALE-MR2316	Black	25 $\frac{1}{2}$ " x 26 $\frac{3}{4}$ " x 34 $\frac{1}{2}$ "	45 lbs.	Each	459.00

ES Series

Stylish modern seating for any workplace.

- Richly padded seats for all day support and comfort.
- Knit mesh back provides lumbar support and breathability.
- Durable steel frame and plastic molded arms.
- Manufacturer's limited five-year warranty.
- Contains 5% post-consumer recycled content, 30% total recycled content.
- Meets or exceeds ANSI/BIFMA Standards.

ID No.	Color	Shpg. Wt.	Qty.	Unit	Price	
D MESH STACK CHAIR						
A modern mesh stack chair that blends perfectly in any office or waiting room. Stacks up to four high (two chairs per carton). Fully assembled. Supports up to 250 lbs. Seat: 20 $\frac{1}{2}$ " x 19 $\frac{1}{4}$ ". Back: 17 $\frac{3}{4}$ " x 16 $\frac{1}{2}$ ". Overall height: 34 $\frac{1}{4}$ ".						
4	ALE-ES4314	Black	60 lbs.	2	Carton	505.00

Eikon Series	Sorrento Series	ES Series	Ispara Series	metaLounge Series
Black	Black	Black	Black	Black

Eikon Series

Contemporary breathable, vented back.

- Contoured mesh back for lumbar support with cushioned mesh seat.
- Durable steel frame with textured matte black finish.
- Fully assembled; just add glides for fixed use or casters for mobility.
- Stacks up to five high (two chairs per carton).
- Manufacturer's limited five-year warranty.
- Meets or exceeds ANSI/BIFMA Standards.

ID No.	Color	Shpg. Wt.	Qty.	Unit	Price	
E STACKING MESH GUEST CHAIR						
Supports up to 250 lbs. Seat: 18 $\frac{1}{2}$ " x 18 $\frac{1}{2}$ ". Back: 17 $\frac{3}{4}$ " x 11 $\frac{1}{4}$ ". Overall height: 33 $\frac{1}{2}$ ".						
5	ALE-EK43ME10B	Black	40 lbs.	2	Carton	455.00

Sorrento Series

Perfect for waiting areas, conference rooms or guest seating.

- Durable and stylish black faux leather upholstery is PVC-free.
- Cushioned seat and base with sturdy black straight steel legs.
- Stacks up to four high.
- Manufacturer's limited five-year warranty.
- Meets or exceeds ANSI/BIFMA Standards.

ID No.	Color	Shpg. Wt.	Qty.	Unit	Price	
F STACKING GUEST CHAIR						
Supports up to 250 lbs. Seat: 20 $\frac{1}{2}$ " x 19 $\frac{1}{2}$ ". Back: 20 $\frac{1}{2}$ " x 12 $\frac{1}{2}$ ". Overall height: 33 $\frac{3}{4}$ ".						
6	ALE-UT6816	Black	46 lbs.	2	Carton	329.00

Prices subject to change without notice. Visit our website for the latest pricing and product information.

Seating Reception Room



Upholstery

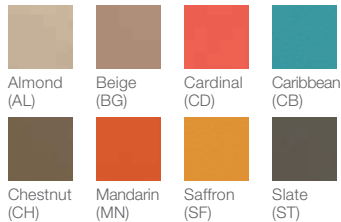

C



D



E



F



A



B



WE Series Collaboration Seating

Configure arcs, cubes or circles for nearly limitless configurations.

- Add waves, linear, or pod seating to fit any space.
- Create instant and adaptable seating for collaboration pods, quick huddle, and reception room requirements.
- Padded benches in coordinated leather upholstery.
- Arcs, wedges and rectangles to make ovals, perfect circles or endless waves.
- Cubes and circles can also be positioned for use as ottomans or side tables.
- Manufacturer's limited five-year warranty.
- Meets or exceeds ANSI/BIFMA Standards.

A - E WE SERIES COLLABORATION SEATING

Contains 15% post-consumer recycled content, 45% total recycled content.

ID No.	Finish/Color	W x D x H	Shpg. Wt.	Unit	Price
1 ALE-WE36CH	Chestnut	38 $\frac{3}{4}$ " x 21" x 18"	21 lbs.	Each	350.00
2 ALE-WE36ST	Slate	38 $\frac{3}{4}$ " x 21" x 18"	21 lbs.	Each	350.00

ID No.	Finish/Color	W x D x H	Shpg. Wt.	Unit	Price
B CIRCLE BENCH					
3 ALE-WE34AL	Almond	18" x 18" x 18"	13 lbs.	Each	200.00
4 ALE-WE34BG	Beige	18" x 18" x 18"	13 lbs.	Each	200.00
5 ALE-WE34CD	Cardinal	18" x 18" x 18"	13 lbs.	Each	200.00
6 ALE-WE34CB	Caribbean	18" x 18" x 18"	13 lbs.	Each	200.00
C CUBE BENCH					
7 ALE-WE35AL	Almond	18" x 18" x 18"	14 lbs.	Each	200.00
8 ALE-WE35BG	Beige	18" x 18" x 18"	14 lbs.	Each	200.00
9 ALE-WE35MN	Mandarin	18" x 18" x 18"	14 lbs.	Each	200.00
10 ALE-WE35SF	Saffron	18" x 18" x 18"	14 lbs.	Each	200.00
D QUARTER WEDGE BENCH					
11 ALE-WE33AL	Almond	25 $\frac{3}{4}$ " x 18" x 18"	14 lbs.	Each	200.00
12 ALE-WE33BG	Beige	25 $\frac{3}{4}$ " x 18" x 18"	14 lbs.	Each	200.00
E RECTANGLE BENCH					
13 ALE-WE37CH	Chestnut	36" x 18" x 18"	25 lbs.	Each	300.00
14 ALE-WE37ST	Slate	36" x 18" x 18"	25 lbs.	Each	300.00

F CIRCLE TABLE

Circle table is the perfect accent. Sturdy and durable laminate top nestles seamlessly with the leather wrapped circle. Laminate top is scratch-, water-, and dent-resistant for long lasting durability. Easily configure and reconfigure. Laminate top. Contains 10% post-consumer recycled content, 40% total recycled content.

15 ALE-WE34TBLST	Slate	18" Diameter	15 lbs.	Each	200.00
------------------	-------	--------------	---------	------	--------



Smart designs, **smart prices!**

Alera office furniture is an impressive combination of innovative styling, high quality and affordability. With hundreds of choices in office suites, seating, tables, storage and more, Alera always delivers the perfect solution that works for you, your space and your bottom line.

See more Alera products at
www.aleradetails.com

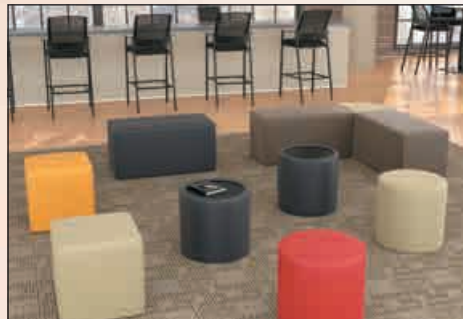



A

Mahogany/
Oxblood



B

Mahogany/
Oxblood



C

Mahogany/
Oxblood



D

Mahogany/
Oxblood



E

Walnut/
Chocolate
Marble

Transitional
Series

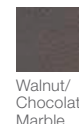

Traditional
Series



Mahogany/
Oxblood



Traditional Series

Traditional styling with brass nailhead trim.

- Deep cushioned bankers style upholstered chairs.
- Genuine hardwood frame with a rich mahogany finish.
- Padded arms for comfort and support.
- Meets or exceeds ANSI/BIFMA standards.
- Manufacturer's limited five-year warranty.



ID No.	Color	Shpg. Wt.	Unit	Price
--------	-------	-----------	------	-------

A HIGH-BACK CHAIR

High-back swivel/tilt chair. Integrated bolstered headrest for enhanced comfort and style. Steel reinforced wood five-star base with casters for easy mobility. Supports up to 250 lbs. Seat: 23" × 19½". Back: 22" × 32½". Overall height: 44½" to 48¾".

1	ALE-TD4136 ★	Mahogany/Oxblood	64 lbs.	Each	659.00
---	--------------	------------------	---------	------	--------

B MID-BACK CHAIR

Mid-back swivel/tilt chair. Steel reinforced wood five-star base with casters for easy mobility. Supports up to 250 lbs.

Seat: 21½" × 19½". Back: 21¼" × 26¾". Overall height: 38¾" to 42¾".

2	ALE-TD4236 ★	Mahogany/Oxblood	61 lbs.	Each	609.00
---	--------------	------------------	---------	------	--------

C GUEST ARM CHAIR WITH CASTERS

Traditional "bankers" styling with straight wood legs. Supports up to 250 lbs.

Seat: 22½" × 20½". Back: 20¾" × 8¾". Overall height: 29½".

3	ALE-TDC4336 ★	Mahogany/Oxblood	31 lbs.	Each	409.00
---	---------------	------------------	---------	------	--------

D GUEST ARM CHAIR

Traditional "bankers" styling with straight wood legs. Supports up to 250 lbs.

Seat: 22½" × 20½". Back: 20¾" × 8¾". Overall height: 29½".

4	ALE-TD4336 ★	Mahogany/Oxblood	31 lbs.	Each	359.00
---	--------------	------------------	---------	------	--------

★ ALE-TD4136, ALE-TD4236—Contains 5% post-consumer recycled content, 20% total recycled content.

ALE-TDC4336, ALE-TD4336—Contains 5% post-consumer recycled content, 30% total recycled content.

Transitional Series Executive Wood Chair



Add a sense of sophistication and warmth to your office.

- Classic wood and leather styling in warm walnut finish and marbled chocolate leather.
- Individually wrapped coil-springs inside a generously cushioned seat provides exceptional mattress-like comfort all day long.
- Distinctive leather padded armrests.
- Steel-reinforced walnut wood base provides exceptional strength and durability.
- Waterfall seat edge reduces pressure points at the back of the knee.
- Meets or exceeds ANSI/BIFMA standards.
- Manufacturer's limited five-year warranty.

ID No.	Color	Shpg. Wt.	Unit	Price
--------	-------	-----------	------	-------

E TRANSITIONAL SERIES EXECUTIVE WOOD CHAIR

Supports up to 250 lbs.

Seat: 23" × 21". Back: 21¾" × 29½". Overall height: 42¾" to 46½".

5	ALE-TS4159W	Walnut/Chocolate Marble	71 lbs.	Each	509.00
---	-------------	-------------------------	---------	------	--------



Pneumatic
Seat Height
Adjustment



Tilt/Tension/
Tilt Lock

For more information on additional chair features see page 22.



A

Black Leather



B

Black Leather



C

Black Leather



Classic elegance in soft touch black leather.



Five-star base adorned with mahogany finish.



Leather padded armrests.



Black Leather



Mahogany Finish



See more Alera products at www.aleradetails.com

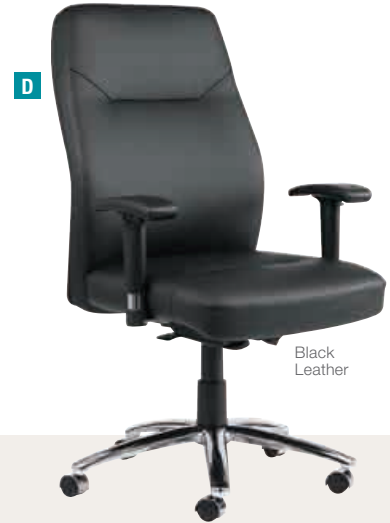

D

Black Leather



Madaris Series

Perfect for executive, conference and general office use.

- Luxurious soft black leather upholstery.
- Padded armrests for comfort.
- Mid-range knee tilt feature keeps your feet on the floor as you recline at a more relaxed angle.
- Waterfall seat edge relieves pressure points at the back of the knees.
- Distinctive leather padded mahogany arms and five-star base.
- Manufacturer's limited five-year warranty.
- Meets or exceeds ANSI/BIFMA Standards.

ID No.	Color	Shpg. Wt.	Unit	Price
A HIGH-BACK KNEE TILT LEATHER CHAIR WITH WOOD TRIM				
Supports up to 250 lbs.				
Seat: 21½" × 20¼". Back: 21½" × 31½". Overall height: 44¾" to 47¾".				
1	ALE-MA41LS10M	Black	58 lbs.	Each 459.00
B MID-BACK KNEE TILT LEATHER CHAIR WITH WOOD TRIM				
Supports up to 250 lbs.				
Seat: 21½" × 20¼". Back: 21½" × 24¾". Overall height: 37¾" to 41".				
2	ALE-MA42LS10M	Black	51 lbs.	Each 449.00
C LEATHER GUEST CHAIR WITH WOOD TRIM LEGS				
Leveling glides for uneven floors. Supports up to 250 lbs.				
Seat: 21¾" × 20¾". Back: 21½" × 24½". Overall height: 35".				
3	ALE-MA43ALS10M	Black	32 lbs.	Each 379.00

LC Leather Series

Luxurious and generously padded leather chair for a busy office environment.

- The self adjusting chair automatically adapts the tilt tension to your body weight and posture as a counter-balance for the ideal reclined position.
- Modern chrome accents.
- Manufacturer's limited five-year warranty.
- Contains 5% post-consumer recycled content, 30% total recycled content.
- Meets or exceeds ANSI/BIFMA Standards.

ID No.	Color	Shpg. Wt.	Unit	Price
D SELF-ADJUSTING LEATHER HIGH-BACK CHAIR				
Supports up to 250 lbs.				
Seat: 21½" × 21¼". Back: 21¼" × 29¾". Overall height: 42¼" to 46"				
4	ALE-LC4119	Black	54 lbs.	Each 509.00

For more information on additional chair features see page 22.



Prices subject to change without notice. Visit our website for the latest pricing and product information.

Strada Series

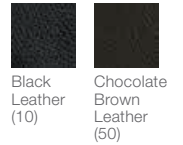

Strada Series

Tailored seat and back with top-grain leather upholstery.

- Roll armrests with padded leather arm caps.
- Waterfall seat reduces pressure at the back of knees.
- Manufacturer's limited five-year warranty.
- Meets or exceeds ANSI/BIFMA Standards.

ID No.	Color	Shpg. Wt.	Unit	Price
--------	-------	-----------	------	-------

A HIGH-BACK SWIVEL/TILT TOP-GRAIN LEATHER CHAIR

Supports up to 250 lbs. Seat: 21" x 21¼". Back: 21" x 28½". Overall height: 43½" to 46½".				
1	ALE-SR41LS10B	Black	51 lbs.	Each 509.00
2	ALE-SR41LS50B	Chocolate Brown	51 lbs.	Each 509.00

B MID-BACK SWIVEL/TILT TOP-GRAIN LEATHER CHAIR

Supports up to 250 lbs. Seat: 21" x 21¼". Back: 21" x 22¾". Overall height: 38½" to 42½".				
3	ALE-SR42LS10B	Black	48 lbs.	Each 469.00
4	ALE-SR42LS50B	Chocolate Brown	48 lbs.	Each 469.00



Pneumatic Seat Height Adjustment



Tilt Tension/Tilt Lock

For more information on additional chair features see page 22.

Veon Series



Black Leather (19)

Brown Leather (59)

A



Black Leather (19)

B



Black Leather (19)



C



Brown Leather (59)



Veon Series

All day mattress-like comfort.

- Coil spring cushioned seat provides long-lasting comfort.
- Ergonomic side bolsters for added support plus integrated leather headrest and padded leather armrests.
- Five-star base with protective foot zones.
- Generously cushioned waterfall seat reduces pressure at the back of the knees.
- Manufacturer's limited five-year warranty.
- Meets or exceeds ANSI/BIFMA Standards.

ID No.	Color	Shpg. Wt.	Unit	Price
A EXECUTIVE HIGH-BACK LEATHER CHAIR				
Adjustable lumbar support for optimal back support. Supports up to 250 lbs. Seat: 21½" × 21½". Back: 22" × 31¾". Overall height: 44½" to 47".				
1	ALE-VN4119	Black	50 lbs.	Each 550-00
2	ALE-VN4159	Brown	50 lbs.	Each 550-00
B LEATHER MID-BACK MANAGER'S CHAIR				
Height adjustable arms. Supports up to 250 lbs. Seat: 20½" × 20½". Back: 20½" × 26½". Overall height: 40½" to 43¼".				
3	ALE-VN5119	Black	45 lbs.	Each 420-00
4	ALE-VN5159	Brown	45 lbs.	Each 420-00
C LOW-BACK LEATHER TASK CHAIR				
Supports up to 250 lbs. Seat: 20½" × 18½". Back: 19½" × 22½". Overall height: 36¼" to 39¼".				
5	ALE-VN6119	Black	35 lbs.	Each 350-00
6	ALE-VN6159	Brown	35 lbs.	Each 350-00

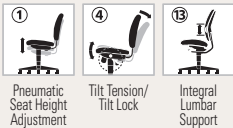

For more information on additional chair features see page 22.



See more Alera products at www.aleradetails.com

17-AL-L-A3L

Seating Leather & Vinyl



Hand-held control mechanism can be set on a variable timer and controls positioning of massage rollers

Security power cord safely detaches if chain is pulled too far from outlet and for trip prevention



Perforated seat and back sections allow for all-day comfort and breathability

Luxurious leather upholstery

Generously cushioned, individually-wrapped coil-spring seat for mattress-like comfort

Black (19)

Shiatsu Massage Chair

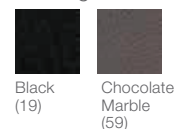

Black (19)

Chocolate Marble (59)

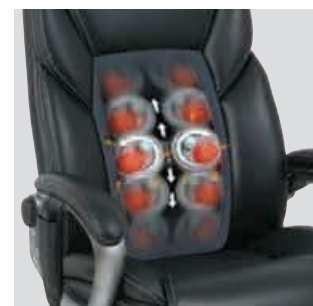

Chocolate Marble (59)



Shiatsu Massage Chair

The seating solution to take the stress out of a busy day.

- Generously cushioned individually wrapped coil-spring seat for a mattress-like comfort.
- Shiatsu style massage rollers move up and down along the back with perfect counter-pressure for stress relief.
- Handheld control mechanism can be set on a variable timer and controls positioning of massage rollers.
- Rollers move from lumbar area to the shoulders.
- Leather chair with perforated seat and back sections allows for all-day comfort and breathability.
- Back locks in infinite positions to allow optimal spinal alignment and weight distribution.
- Wire management design allows the cords to be pulled left, right or center depending on your requirements.
- Security power cord safely detaches if chair pulled too far from outlet and for trip prevention.
- Waterfall seat edge relieves pressure on the back of the knees.
- Manufacturer's limited five-year warranty.
- Contains 14% total recycled content.
- Meets or exceeds ANSI/BIFMA Standards.

ID No.	Color	Shpg. Wt.	Unit	Price
--------	-------	-----------	------	-------

A SHIATSU MASSAGE CHAIR

Supports up to 250 lbs.

Seat: 22 $\frac{7}{8}$ " x 23 $\frac{1}{4}$ ". Back: 21 $\frac{1}{8}$ " x 30 $\frac{1}{2}$ ". Overall height: 44 $\frac{1}{2}$ " to 47 $\frac{1}{2}$ ".

1	ALE-SH7019	Black	51 lbs.	Each	655.00
2	ALE-SH7059	Chocolate Marble	51 lbs.	Each	649.00
Heated —Heating features to soothe aching muscles.					
3	ALE-SH7119	Black	55 lbs.	Each	689.00
4	ALE-SH7159	Chocolate Marble	55 lbs.	Each	689.00

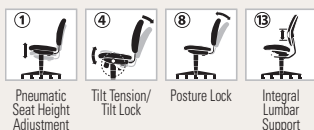

For more information on additional chair features see page 22.

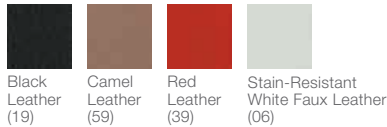

Neratoli® Series

Contemporary cushioned seating with a slim profile.

- Chrome accents.
- Waterfall seat reduces pressure on the back of the knees for improved circulation.
- Padded arm caps for comfort and support.
- Manufacturer's limited five-year warranty.
- Contains 5% post-consumer recycled content, 30% total recycled content.
- Meets or exceeds ANSI/BIFMA Standards.



ID No.	Color	Shpg. Wt.	Unit	Price
A HIGH-BACK SLIM PROFILE CHAIR				
Supports up to 250 lbs. Seat: 19" × 20 3/4". Back: 18 1/2" × 25 3/4". Overall height: 42 1/8" to 45 1/4". ① ④				
Leather				
1	ALE-NR4119	Black	49 lbs.	Each 499-00
2	ALE-NR4159	Camel	49 lbs.	Each 489-00
3	ALE-NR4139	Red	49 lbs.	Each 499-00
Stain-Resistant Upholstery —Treated faux leather wipes clean for a perfect white.				
4	ALE-NR4106	White	49 lbs.	Each 499-00
B MID-BACK SLIM PROFILE CHAIR				
Supports up to 250 lbs. Seat: 19" × 20 3/4". Back: 18 1/2" × 20 3/4". Overall height: 39" to 42 1/8". ① ④				
Leather				
5	ALE-NR4219	Black	48 lbs.	Each 469-00
6	ALE-NR4259	Camel	48 lbs.	Each 459-00
7	ALE-NR4239	Red	48 lbs.	Each 469-00
Stain-Resistant Upholstery —Treated faux leather wipes clean for a perfect white.				
8	ALE-NR4206	White	48 lbs.	Each 469-00

ID No.	Color	Shpg. Wt.	Unit	Price
C LOW-BACK SLIM PROFILE CHAIR				
Supports up to 250 lbs. Seat: 20 1/2" × 17 3/4". Back: 19 5/8" × 15 1/4". Overall height: 34 1/4" to 38 1/8". ① ④				
Leather				
9	ALE-NR4719	Black	32 lbs.	Each 399-00
10	ALE-NR4759	Camel	32 lbs.	Each 399-00
11	ALE-NR4739	Red	32 lbs.	Each 399-00
Stain-Resistant Upholstery —Treated faux leather wipes clean for a perfect white.				
12	ALE-NR4706	White	32 lbs.	Each 399-00
D SLIM PROFILE GUEST CHAIR				
Supports up to 250 lbs. Seat: 20 3/4" × 21 1/4". Back: 20 1/4" × 23 1/4". Overall height: 37".				
13	ALE-NR4319	Black	44 lbs.	Each 309-00

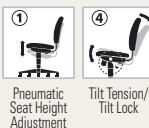

For more information on additional chair features see page 22.

17-AL-L-A3L

Seating Leather



Black Leather



Fraze Chair

Ultra-soft cushions, side bolsters and lumbar bolsters for maximum support.

- Plush, thickly-padded headrest and arm rests.
- Soft leather upholstery for style and comfort.
- Manufacturer's limited five-year warranty.
- Meets or exceeds ANSI/BIFMA Standards.

ID No.	Color	Shpg. Wt.	Unit	Price
A HIGH-BACK SWIVEL/TILT LEATHER CHAIR				
Supports up to 250 lbs. Seat: 21 $\frac{3}{4}$ " x 20 $\frac{1}{2}$ ". Back: 21 $\frac{3}{4}$ " x 28 $\frac{3}{4}$ ". Overall height: 41 $\frac{1}{4}$ " to 44 $\frac{3}{4}$ ".				
1	ALE-FZ41LS10B	Black	46 lbs.	Each 365.00

CC Leather Series

Generously cushioned high-back executive leather chair makes a statement with bold contrast stitching.

- A soft and highly comfortable leather chair for the busy executive.
- Plush side and seat bolsters with integrated headrest.
- Padded leather adjustable arms.
- Domed five star base with hooded casters for easy mobility.
- Manufacturer's limited five-year warranty.
- Contains 12% post-consumer recycled content, 12% total recycled content.
- Meets or exceeds ANSI/BIFMA Standards.

ID No.	Color	Shpg. Wt.	Unit	Price
B EXECUTIVE HIGH-BACK SWIVEL/TILT LEATHER CHAIR				
Supports up to 250 lbs. Seat: 20 $\frac{1}{8}$ " x 20". Back: 20 $\frac{1}{8}$ " x 29 $\frac{1}{2}$ ". Overall height: 41 $\frac{1}{8}$ " to 45".				
2	ALE-CC4119	Black	42 lbs.	Each 305.00



YR Series

The one chair for the busy office—durability, looks and versatility for anywhere you need a seat.

- Classic modern styling in durable leather upholstery.
- Slightly arched loop arms provide the perfect positioning.
- Manufacturer's limited five-year warranty.
- Contains 5% post-consumer recycled content, 30% total recycled content.
- Meets or exceeds ANSI/BIFMA Standards.

ID No.	Color	Shpg. Wt.	Unit	Price
C EXECUTIVE HIGH-BACK SWIVEL/TILT LEATHER CHAIR				
Supports up to 250 lbs. Seat: 21 $\frac{1}{4}$ " x 20 $\frac{1}{2}$ ". Back: 20 $\frac{1}{8}$ " x 25 $\frac{1}{4}$ ". Overall height: 39 $\frac{3}{4}$ " to 43 $\frac{3}{4}$ ".				
3	ALE-YR4119	Black	38 lbs.	Each 269.00

Sparis Series

A versatile chair for management, conference and general office use.

- Soft leather upholstery.
- Built-in headrest for relaxed comfort.
- Manufacturer's limited five-year warranty.
- Meets or exceeds ANSI/BIFMA Standards.

ID No.	Color	Shpg. Wt.	Unit	Price
D HIGH-BACK SWIVEL/TILT LEATHER CHAIR				
Supports up to 250 lbs. Seat: 20" x 20 $\frac{1}{2}$ ". Back: 20 $\frac{1}{2}$ " x 27 $\frac{3}{4}$ ". Overall height: 42 $\frac{1}{2}$ " to 46 $\frac{3}{4}$ ".				
4	ALE-SP41LS10B	Black	39 lbs.	Each 255.00



For more information on additional chair features see page 22.



CA Series

Have it all with sleek simple styling, a generously padded seat, and the luxurious feel of leather.

- Rich padded seat and back for all day comfort.
- Integrated headrest bolster.
- Adjustable T-arms with soft padded polyurethane armrests for optimal arm positioning.
- Manufacturer's limited five-year warranty.
- Meets or exceeds ANSI/BIFMA Standards.

ID No.	Color	Shpg. Wt.	Unit	Price
--------	-------	-----------	------	-------

A HIGH-BACK SWIVEL/TILT LEATHER CHAIR

Supports up to 250 lbs.
 Seat: 20" × 19½". Back: 19¾" × 25¾". Overall height: 39¾" to 43½". ① ④

1	ALE-CA4119	Black	41 lbs.	Each	299.00
2	ALE-CA4159	Taupe	41 lbs.	Each	299.00

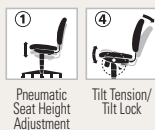

For more information on additional chair features see page 22.



See more Alera products at www.aleradetails.com



CL Leather Series

The economical choice with both comfort and style.

- Soft leather upholstery with integrated headrest.
- Thick padded seat with bolster to support legs.
- Slant loop arms provide support while allowing chair to easily fit under desk.
- Manufacturer's limited five-year warranty.
- Contains 12% post-consumer recycled content, 12% total recycled content.
- Meets or exceeds ANSI/BIFMA Standards.

ID No.	Color	Shpg. Wt.	Unit	Price
--------	-------	-----------	------	-------

B HIGH-BACK LEATHER CHAIR

Supports up to 250 lbs.
 Seat: 21" × 21¾". Back: 28" × 20½". Overall height: 41¾" to 45½". ① ④

4	ALE-CL4119	Black	40 lbs.	Each	250.00
---	------------	-------	---------	------	--------

PF Series

Functionality, high-style and bolstered seat cushion are ideal in any office.

- Ergonomically contoured seat and back designed for optimal support.
- Richly padded leather chair provides all-day comfort.
- Padded loop arms for ideal arm positioning and support.
- Manufacturer's limited five-year warranty.
- Contains 5% post-consumer recycled content, 30% total recycled content.
- Meets or exceeds ANSI/BIFMA Standards.

ID No.	Color	Shpg. Wt.	Unit	Price
--------	-------	-----------	------	-------

C MID-BACK LEATHER OFFICE CHAIR

Supports up to 250 lbs.
 Seat: 21½" × 20¾". Back: 20½" × 24¾". Overall height: 38½" to 42½". ① ④

5	ALE-PF4219	Black	42 lbs.	Each	279.00
---	------------	-------	---------	------	--------

Prices subject to change without notice.
 Visit our website for the latest pricing and product information.

Seating Mesh



Easy-reach seat levers for height and back adjustments.



Arms are adjustable up and down, front to back and at angles.



Easily access seat slide lever for seat depth adjustment.



See more Alera products at www.aleradetails.com



EQ Series

A high-tech aesthetic chair with premium ergonomic features.

- Wire control synchro-tilt mechanism offers customized support.
- Breathable elastic polyester mesh seat, back and headrest.
- Waterfall seat reduces pressure at the back of your knees for improved circulation.
- Easy reach seat levers for height and back adjustment.
- Soft arms are adjustable up and down front to back and at angles.
- Five-star base with casters for easy mobility.
- Manufacturer's limited five-year warranty.
- Meets or exceeds ANSI/BIFMA Standards.

ID No.	Color	Shpg. Wt.	Unit	Price
--------	-------	-----------	------	-------

A ERGONOMIC MULTIFUNCTION MID-BACK MESH CHAIR

Supports up to 250 lbs. Seat: 20 $\frac{1}{2}$ " x 18 $\frac{1}{8}$ ". Back: 20 $\frac{1}{2}$ " x 24 $\frac{1}{2}$ ". Overall height: 37 $\frac{3}{8}$ " to 42 $\frac{3}{8}$ ".

Mesh/Aluminum Base

1	ALE-EQA42ME10A	Black	62 lbs.	Each	1,100.00
---	----------------	-------	---------	------	----------

Mesh/Black Base

2	ALE-EQA42ME10B	Black	62 lbs.	Each	1,100.00
---	----------------	-------	---------	------	----------

OPTIONAL HEADREST

Ergonomic headrest for the Alera® EQ Series. Turn any EQ Series chair into an executive high-back chair with these easy to install headrests. Headrest is height adjustable, forward or backward adjustable, and at angles for a perfect fit. Headrest includes upper back support which can function as a garment hanger.

3	ALE-EQHR18	Black	6 lbs.	Each	89.00
---	------------	-------	--------	------	-------

K8 Series

Advanced ergonomic technology combined with luxurious elegance.

- Suspension mesh provides firmness, breathability and comfort.
- High tech wire control mechanism provides easy reach access to all levers.
- Soft padded arms adjust up and down and front to back.
- Waterfall seat reduces pressure points at the back of the knee.
- Manufacturer's limited five-year warranty.
- Meets or exceeds ANSI/BIFMA Standards.

ID No.	Color	Shpg. Wt.	Unit	Price
--------	-------	-----------	------	-------

B ERGONOMIC MULTIFUNCTION MESH CHAIR

Supports up to 250 lbs. Seat: 19 $\frac{1}{2}$ " x 18 $\frac{1}{8}$ ". Back: 18 $\frac{3}{8}$ " x 23 $\frac{3}{8}$ ". Overall height: 39 $\frac{3}{8}$ " to 42 $\frac{3}{8}$ ".

4	ALE-KE4218	Black	51 lbs.	Each	839.00
---	------------	-------	---------	------	--------

OPTIONAL HEADREST

Sleek design and easy attachment. Adjustable matching mesh headrest for use with K8 Series Chair.

5	ALE-KEHR18	Black	3 lbs.	Each	60.00
---	------------	-------	--------	------	-------

For more information on additional chair features see page 22.

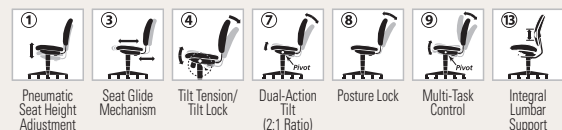



Embré Series

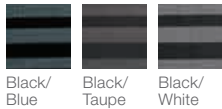

Eon Series

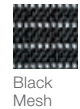

Eon Series

Contemporary design with cool comfort.

- Sleek and easy to use multifunction wire mechanism adjusts seat and back independently while providing tilt and infinite locking positions.
- Adjustable seat depth for optimal back and leg positioning.
- Manufacturer's limited five-year warranty.
- Meets or exceeds ANSI/BIFMA Standards.



Embré Series

Modern mesh striped design adds instant style to your office.

- Ergonomically contoured seat back design supports and hugs the lower back.
- Breathable mesh back and generously padded seat for all day comfort.
- Waterfall seat edge helps to reduce pressure points at the back of knee.
- Height adjustable arms for optimal arm positioning.
- Manufacturer's limited five-year warranty.
- Contains 16% total recycled content.
- Meets or exceeds ANSI/BIFMA Standards.

ID No.	Color	Shpg. Wt.	Unit	Price
A MULTIFUNCTION MID-BACK SUSPENSION MESH CHAIR				
Supports up to 250 lbs. Seat: 20¼" × 20½". Back: 18½" × 23¼". Overall height: 39¾" to 43¾".				
1	ALE-EN4218 Black	54 lbs.	Each	555-00
B MULTIFUNCTION MID-BACK CUSHIONED MESH CHAIR				
Supports up to 250 lbs. Seat: 20¼" × 20½". Back: 18½" × 23¼". Overall height: 39¾" to 43¾".				
2	ALE-EN4217 Black	55 lbs.	Each	525-00
C MULTIFUNCTION MID-BACK LEATHER/MESH CHAIR				
Supports up to 250 lbs. Seat: 20¼" × 20½". Back: 18½" × 23¼". Overall height: 40¾" to 43¾".				
3	ALE-EN4215 Black	58 lbs.	Each	535-00

ID No.	Color	Shpg. Wt.	Unit	Price
D MESH MID-BACK CHAIR				
Supports up to 250 lbs. Seat: 21¼" × 19¾". Back: 18¾" × 26¾". Overall height: 38¾" to 42¾".				
4	ALE-EM4224 Black/Blue	40 lbs.	Each	349-00
5	ALE-EM4254 Black/Taupe	40 lbs.	Each	349-00
6	ALE-EM4204 Black/White	40 lbs.	Each	349-00



For more information on additional chair features see page 22.

Prices subject to change without notice.
Visit our website for the latest pricing and product information.



One collection for the whole office



Elusion Series

A contoured design and breathable mesh come together to create this cool complement to any workplace. With a range of features and functions, this top-selling collection has a style that's right for everyone and everywhere—the perfect combination of versatility and value.



Adjustable Ratchet Back

Make quick and easy adjustments for optimal lumbar support with the ratcheting back.



Adjustable Arms

Customize your comfort with softly-padded height- and width-adjustable arms.

Elusion Series

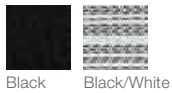

Elusion™ Series

Clean, classic styling complements the busy office environment.

- Contoured seat cushion with waterfall edge to help relieve pressure on legs.
- Height- and width-adjustable arms with soft polyurethane pads.
- Five-star base with casters for easy mobility.
- Breathable mesh back for all day support.
- Height adjustable ratchet back for optimal lumbar support.
- Manufacturer's limited five-year warranty.
- Meets or exceeds ANSI/BIFMA Standards.

ID No.	Color	Shpg. Wt.	Unit	Price
--------	-------	-----------	------	-------

A MESH HIGH-BACK MULTIFUNCTION CHAIR WITH SEAT SLIDE

Supports up to 250 lbs.
Seat: 20½" × 21". Back: 20½" × 24". Overall height: 41" to 46¾".

Premium Fabric Upholstery

1	ALE-EL41ME10B	Black	58 lbs.	Each	525.00
---	---------------	-------	---------	------	--------

B MESH MID-BACK MULTIFUNCTION CHAIR WITH SEAT SLIDE

Supports up to 250 lbs.
Seat: 20½" × 21". Back: 20½" × 20½". Overall height: 36¾" to 42¾".

Leather Upholstery

2	ALE-EL4215	Black	58 lbs.	Each	505.00
---	------------	-------	---------	------	--------

Premium Fabric Upholstery

3	ALE-EL42ME10B	Black	57 lbs.	Each	485.00
---	---------------	-------	---------	------	--------

C MESH MID-BACK SWIVEL/TILT CHAIR

Ergonomic design adjusts to fit multiple users. Supports up to 250 lbs.

Air Mesh Seat Upholstery

Seat: 21" × 20½". Back: 20½" × 20½". Overall height: 27" to 40¾".

4	ALE-EL42B18	Black	50 lbs.	Each	505.00
---	-------------	-------	---------	------	--------

Premium Fabric Upholstery

Seat: 20½" × 21". Back: 20½" × 20½". Overall height: 27" to 40¾".

5	ALE-EL42BME10B	Black	48 lbs.	Each	375.00
---	----------------	-------	---------	------	--------

6	ALE-EL42B04	Black/White	48 lbs.	Each	375.00
---	-------------	-------------	---------	------	--------

D MESH STOOL

Ergonomically designed stool adjusts to fit multiple users. Cool, breathable mesh back. Adjustable foot ring for leg support. Supports up to 250 lbs.

Seat: 20½" × 21". Back: 20½" × 20½". Overall height: 42½" to 51¾".

7	ALE-EL4614	Black	53 lbs.	Each	505.00
---	------------	-------	---------	------	--------



Mesh Guest Stacking Chair

Coordinate mesh chair for training, conference or waiting rooms.

- Cool breathable mesh back upholstery stacks up to 5 high.
- Includes both glides for fixed use and casters for mobility.
- Provides long lasting support.
- Manufacturer's limited five-year warranty.
- Contains 5% post-consumer recycled content, 20% total recycled content.

ID No.	Color	Shpg. Wt.	Unit	Price
--------	-------	-----------	------	-------

E MESH GUEST STACK CHAIR

Supports up to 250 lbs. Seat: 18½" × 18¾". Back: 20¾" × 17¾". Overall height: 36¼".

8	ALE-EL4314	Black	23 lbs.	Each	305.00
---	------------	-------	---------	------	--------

For more information on additional chair features see page 22.



Prices subject to change without notice.
Visit our website for the latest pricing and product information.

Seating Mesh



EX Series



Black

Epoch Series



Black Mesh Seat
Black Mesh Fabric



EX Series

Ergonomically designed for the modern workplace.

- Mesh back for cool comfort and cushioned fabric seat.
- Manufacturer's limited five-year warranty.
- Contains 20% pre-consumer recycled content, 10% post-consumer recycled content, 30% total recycled content.
- Meets or exceeds ANSI/BIFMA Standards.

ID No.	Color	Shpg. Wt.	Unit	Price
--------	-------	-----------	------	-------

A MESH MULTIFUNCTION MID-BACK CHAIR

Ratchet back height adjustment and multifunction mechanism with seat slide to accommodate most users. Height- and width-adjustable arms for optimal positioning. Supports up to 250 lbs.

Seat: 20 $\frac{3}{8}$ " x 18 $\frac{1}{8}$ ". Back: 20" x 20". Overall height: 37 $\frac{7}{8}$ " to 41 $\frac{1}{8}$ ".

1	ALE-EX4214	Black	54 lbs.	Each	465-00
---	------------	-------	---------	------	--------

B MESH MULTIFUNCTION HIGH-BACK CHAIR

Integrated adjustable lumbar support. Multifunction mechanism with seat slide accommodates most users. Height- and width-adjustable arms for optimal positioning. Supports up to 250 lbs.

Seat: 20 $\frac{3}{8}$ " x 18 $\frac{1}{8}$ ". Back: 20 $\frac{3}{8}$ " x 21 $\frac{1}{4}$ ". Overall height: 41" to 44 $\frac{1}{2}$ ".

2	ALE-EX4114	Black	55 lbs.	Each	505-00
---	------------	-------	---------	------	--------



Epoch Series

Aesthetically designed for a contemporary feel.

- Mesh-covered curved back for added support.
- Five-star base with casters.
- Contoured seat for comfort.
- Multiple adjustments for each user's needs.
- Height adjustable T-bar arms.
- Ratchet back for ideal lumbar placement.
- Manufacturer's limited five-year warranty.
- Meets or exceeds ANSI/BIFMA Standards.

ID No.	Color	Shpg. Wt.	Unit	Price
--------	-------	-----------	------	-------

C SUSPENSION MESH MID-BACK CHAIR

Mesh suspension seat for cool comfort. Supports up to 250 lbs.

Seat: 20 $\frac{1}{8}$ " x 19 $\frac{1}{8}$ ". Back: 18 $\frac{1}{2}$ " x 28 $\frac{3}{4}$ ". Overall height: 38 $\frac{1}{2}$ " to 43 $\frac{3}{4}$ ".

3	ALE-EP4218	Black	49 lbs.	Each	499-00
---	------------	-------	---------	------	--------

D FABRIC MESH MULTIFUNCTION CHAIR

Cushioned fabric mesh seat adjusts back angle with a single lever. Supports up to 250 lbs. Seat: 19" x 18 $\frac{1}{4}$ ". Back: 18 $\frac{1}{2}$ " x 28 $\frac{3}{4}$ ". Overall height: 39 $\frac{1}{2}$ " to 44 $\frac{3}{4}$ ".

4	ALE-EP42ME10B	Black	46 lbs.	Each	425-00
---	---------------	-------	---------	------	--------

For more information on additional chair features see page 22.

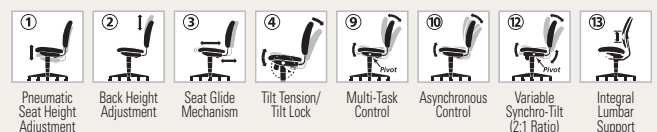

See more Alera products at www.aleradetails.com



EB Series

Advanced ergonomics combined with intelligent design fits most any user.

- Synchro function tilts back in a 2:1 ratio to the seat for a more natural reclining position.
- Breathable mesh back and generously padded seat for all-day comfort.
- Unique action pivoting arms accommodates the busy on-the-go user.
- Waterfall seat edge reduces pressure points at the back of the knee.
- Manufacturer's limited five-year warranty.
- Contains 5% post-consumer recycled content, 30% total recycled content.
- Meets or exceeds ANSI/BIFMA Standards. ♻️ ♻️ ♻️

ID No. Color Shpg. Wt. Unit Price

A PIVOT ARM MULTIFUNCTION MESH CHAIR

Pivoting swing arms adjust inward when leaning forward for close-in tasks or swing out to accommodate the wingspan. Arms also adjust up or down and front and back. Supports up to 250 lbs.

Seat: 20" × 21½" Back: 19½" × 23¼" Overall height: 38¾" to 42¾". ① ③ ④ ⑫ ⑬

1 ALE-EBW4213 Black 54 lbs. Each 795.00

B SYNCHO MID-BACK FLIP-ARM CHAIR

Flip-back height adjustable arms neatly pivot backward and out of the way when not needed. Integrated adjustable lumbar support bar for ideal posture. Leather seat. Plastic back frame resists impacts in high-traffic areas. Supports up to 250 lbs.

Seat: 20½" × 20½" Back: 18¾" × 26½" Overall height: 37¾" to 41¾". ① ④ ⑬

Black Frame

2 ALE-EBT4215 Black 38 lbs. Each 449.00

Cool Gray Frame

3 ALE-EBT4205 Black/Gray 38 lbs. Each 449.00

C SYNCHRO MID-BACK MESH CHAIR

Flip-back arms neatly pivot backward and out of the way when not needed. Supports up to 250 lbs.

Seat: 20¼" × 20½" Back: 18¾" × 23¼" Overall height: 39" to 42¾". ① ④ ⑫

Black Frame

4 ALE-EBK4217 Black 45 lbs. Each 405.00

Cool Gray Frame

5 ALE-EBK4207 Black 45 lbs. Each 405.00



For more information on additional chair features see page 22.

Seating Mesh



A



B



Molded Seat



Adjustable Lumbar



C



D

Black

Black

Black

Black



Black



Envy Series

Crisp visual design and a variety of ergonomic adjustments at an irresistible price.

- Contoured seat cushion with waterfall edge helps relieve pressure on legs.
- Adjustable-height and -width arms move up and down, as well as toward and away from the body to adapt to various body sizes.
- Lumbar adjustment supports the lower back and can be adjusted to satisfy a variety of different users.
- Manufacturer's limited five-year warranty.
- Meets or exceeds ANSI/BIFMA Standards.

For more information on additional chair features see page 22.



ID No.	Color	Shpg. Wt.	Unit	Price
--------	-------	-----------	------	-------

A MESH HIGH-BACK MULTIFUNCTION CHAIR

Asynchronous control offers a wide range of movement, assists in spinal alignment and distributes user's weight evenly. Infinite tilt lock secures chair at nearly any reclining angle. Supports up to 250 lbs.
Seat: 20" × 20½". Back: 17½" × 25". Overall height: 41¾" to 46½".

1	ALE-NV41M14	Black	45 lbs.	Each	549.00
---	-------------	-------	---------	------	--------

B MESH HIGH-BACK SWIVEL/TILT CHAIR

Upright tilt lock secures chair in full upright position for additional support. Supports up to 250 lbs.
Seat: 20" × 20½". Back: 17½" × 25". Overall height: 42¼" to 46¾".

2	ALE-NV41B14	Black	45 lbs.	Each	439.00
---	-------------	-------	---------	------	--------

C MESH MID-BACK MULTIFUNCTION CHAIR

Asynchronous control offers a wide range of movement, assists in spinal alignment and distributes user's weight evenly. Infinite tilt lock secures chair at nearly any reclining angle. Supports up to 250 lbs.
Seat: 20" × 20½". Back: 17½" × 22½". Overall height: 40" to 43¾".

3	ALE-NV42M14	Black	45 lbs.	Each	509.00
---	-------------	-------	---------	------	--------

D MESH MID-BACK SWIVEL/TILT CHAIR

Swivel-tilt with lock and tension control which allows users to adjust to the demands of the workday. Supports up to 250 lbs.
Seat: 20" × 20½". Back: 17½" × 22½". Overall height: 37" to 41½".

4	ALE-NV42B14	Black	45 lbs.	Each	399.00
---	-------------	-------	---------	------	--------



A

Black



EY Series



Black



B

Black

Logan Series



Black



C

Black

ENR Series



Black



EY Series Mesh Multifunction Chair

Dramatic slim profile chair with soft knit-like mesh upholstery.

- Advanced variable synchro-tilt mechanism allows a more relaxed 2:1 back to seat recline with four locking positions.
- Coil spring seat interior for a superior mattress-like seat.
- Height-adjustable arms with naturally sloped arm pads.
- Durable and stylish five-star chrome base with easy-rolling casters.
- Manufacturer's limited five-year warranty.
- Contains 25% pre-consumer recycled content, 5% post-consumer recycled content, 30% total recycled content.
- Meets or exceeds ANSI/BIFMA Standards.

ID No.	Color	Shpg. Wt.	Unit	Price
--------	-------	-----------	------	-------

A MESH SYNCRO CHAIR WITH COIL SPRING CUSHION

Supports up to 250 lbs.

Seat: 20½" × 20½". Back: 18½" × 28½". Overall height: 41¾" to 45¾".

1	ALE-EY4114	Black	40 lbs.	Each	595.00
---	------------	-------	---------	------	--------



1
Pneumatic Seat Height Adjustment



4
Tilt Tension/Tilt Lock



12
Variable Synchro-Tilt (2:1 Ratio)

For more information on additional chair features see page 22.

Logan Series

Contoured cushions with mesh fabric upholstery provide plush comfort and all-day support.

- Closed loop arms with padded mesh fabric arm pads.
- Five-star base with hooded casters for easy mobility.
- Manufacturer's limited five-year warranty.
- Meets or exceeds ANSI/BIFMA Standards.

ID No.	Color	Shpg. Wt.	Unit	Price
--------	-------	-----------	------	-------

B MESH HIGH-BACK SWIVEL/TILT CHAIR

Supports up to 250 lbs.

Seat: 21½" × 21" Back: 21¼" × 27¾" Overall height: 41½" to 45½".

2	ALE-LG41ME10B	Black	43 lbs.	Each	395.00
---	---------------	-------	---------	------	--------

ENR Series

Contemporary cushioned mesh chair with a slim profile.

- Breathable mesh upholstery with chrome accents.
- Soft polyurethane padded chrome arms for comfort and style.
- Generously padded mesh seat for all day comfort.
- Waterfall seat edge reduces pressure points at the back of the knee.
- Manufacturer's limited five-year warranty.
- Contains 5% post-consumer recycled content, 30% total recycled content.
- Meets or exceeds ANSI/BIFMA Standards.

ID No.	Color	Shpg. Wt.	Unit	Price
--------	-------	-----------	------	-------

C MID-BACK SLIM PROFILE MESH CHAIR

Supports up to 250 lbs.

Seat: 20½" × 21½" Back: 19¾" × 21½" Overall height: 37¾" to 41¾".

3	ALE-ENR4218	Black/Chrome	40 lbs.	Each	455.00
---	-------------	--------------	---------	------	--------

Prices subject to change without notice.

Visit our website for the latest pricing and product information.

Seating Mesh



Etros Series



Black Fabric Black Mesh



Etros Series

An economical choice for mesh comfort.

- Breathable mesh back with cushioned mesh fabric seat.
- Adjustable lumbar support.
- Five-star base with casters for easy mobility.
- Manufacturer's limited five-year warranty.
- Meets or exceeds ANSI/BIFMA Standards.

For more information on additional chair features see page 22.

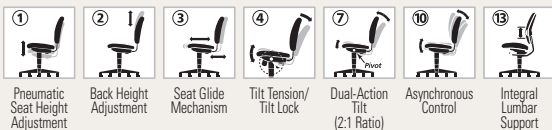

ID No.	Color	Shpg. Wt.	Unit	Price
A SUSPENSION MESH MID-BACK SYNCHRO TILT CHAIR				
Mesh suspension seat and back provides firmness, breathability and comfort. Back reclines at 2-to-1 angle to the seat allowing user to recline while keeping seat relatively even with the floor. Supports up to 250 lbs.				
Seat: 20 $\frac{1}{2}$ " × 19 $\frac{1}{4}$ ". Back: 19" × 23 $\frac{3}{4}$ ". Overall height: 35 $\frac{3}{4}$ " to 39 $\frac{3}{4}$ ".				
1	ALE-ET4218	Black	44 lbs.	Each 355.00
B MESH MID-BACK CHAIR				
Breathable mesh back with cushioned mesh fabric seat. Supports up to 250 lbs.				
Seat: 20 $\frac{1}{2}$ " × 20 $\frac{1}{4}$ ". Back: 19" × 23 $\frac{3}{4}$ ". Overall height: 36 $\frac{3}{4}$ " to 40 $\frac{3}{4}$ ".				
2	ALE-ET42ME10B	Black	34 lbs.	Each 275.00
C MESH MID-BACK PETITE MULTIFUNCTION CHAIR				
Designed for the petite user, but adjustable to fit all. Three-lever multifunction mechanism for complete control of the back angle relative to seat, seat slide and forward tilt. Height- and width-adjustable arms with soft polyurethane armcaps for ideal arm placement. Tilt lock and tilt tension controls rate of recline to accommodate any user. Supports up to 250 lbs. Seat: 20 $\frac{1}{2}$ " × 17 $\frac{3}{4}$ ". Back: 18 $\frac{1}{2}$ " × 27 $\frac{3}{4}$ ". Overall height: 36 $\frac{1}{4}$ " to 41 $\frac{3}{4}$ ".				
3	ALE-ET4017	Black	53 lbs.	Each 385.00
D HEIGHT ADJUSTABLE MESH STOOL				
Supports up to 250 lbs.				
Seat: 20 $\frac{1}{4}$ " × 20 $\frac{1}{2}$ ". Back: 19" × 20 $\frac{3}{4}$ ". Overall height: 44 $\frac{1}{4}$ " to 54 $\frac{1}{4}$ ".				
4	ALE-ET4614	Black	40 lbs.	Each 349.00



A

new

Black



B

new

Black Fabric



C

new

Blue Fabric

Wrigley 24/7



Black



Wrigley Series



Black Fabric



Blue Fabric



D



Anthracite



Wrigley High Performance Series

Ergonomic design for all-day comfort.

- Waterfall seat edge relieves pressure on legs.
- Padded T-arms are height- and width-adjustable for extra comfort.
- Durable fabric upholstery, impact-resistant molded black plastic shell and black nylon five-star base with casters for easy mobility.
- Manufacturer's limited five-year warranty.
- Contains 5% post-consumer recycled content, 30% total recycled content.
- Meets or exceeds ANSI/BIFMA Standards.

ID No.	Color	Shpg. Wt.	Unit	Price
--------	-------	-----------	------	-------

A 24/7 HIGH PERFORMANCE MID-BACK MULTIFUNCTION TASK CHAIR

Enhanced support to withstand use through multiple shifts. Stronger mechanism and base for heavy-duty 24/7 use allows back angle adjustments relative to seat, adjustable tilt (free floating or infinite locking positions) and forward tilt. Supports up to 250 lbs.

Seat: 21¼" × 20⅞". Back: 19¼" × 21½". Overall height: 39¾" to 42⅞".

1	ALE-HPT4201	Black	55 lbs.	Each	499-00
---	-------------	-------	---------	------	--------

B HIGH PERFORMANCE MID-BACK SYNCHRO-TILT TASK CHAIR

Designed to last in the busy office with smart ergonomic features for optimal comfort. Synchro-tilt mechanism allows back to recline in a 2-to-1 ratio to the seat to help keep your feet on the ground even when leaning back. Supports up to 250 lbs.

Seat: 20⅞" × 19½". Back: 18¾" × 21¼". Overall height: 38½" to 40½".

2	ALE-HPS4201	Black	47 lbs.	Each	349-00
3	ALE-HPS4202	Blue	47 lbs.	Each	349-00

C HIGH PERFORMANCE MID-BACK MULTIFUNCTION TASK CHAIR

Designed to last in the busy office with smart ergonomic features for optimal comfort. Multifunction mechanism allows back angle adjustment relative to seat and adjustable tilt (free floating or infinite locking positions). Supports up to 250 lbs.

Seat: 20⅞" × 19½". Back: 18¾" × 21¼". Overall height: 38½" to 42½".

4	ALE-HPM4201	Black	55 lbs.	Each	419-00
5	ALE-HPM4202	Blue	55 lbs.	Each	419-00

Everyday Task Series

The one chair suitable for all your everyday work tasks.

- Contoured padded seat and back provides superior comfort and ergonomics.
- Waterfall seat edge relieves pressure on the back of legs and knee.
- Adjustable height padded arms.
- Manufacturer's limited five-year warranty.
- Contains 9% pre-consumer recycled content, 9% total recycled content.
- Meets or exceeds ANSI/BIFMA Standards.

ID No.	Color	Shpg. Wt.	Unit	Price
--------	-------	-----------	------	-------

D SWIVEL/TILT CHAIR

Supports up to 250 lbs.

Seat: 20⅞" × 19¾". Back: 20⅞" × 18⅞". Overall height: 37" to 40¼".

6	ALE-TE4711	Anthracite	55 lbs.	Each	309-00
---	------------	------------	---------	------	--------

For more information on additional chair features see page 22.



Prices subject to change without notice. Visit our website for the latest pricing and product information.

Seating Office



A Shown with Optional Fixed T-Arms

Black Leather (19)



A Shown with Optional Fixed T-Arms

Parrot Green (71)



B new

Marine Blue (21)



B new

Black Leather (16)

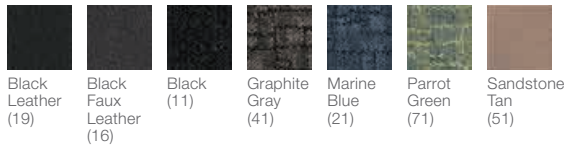

Black Leather (19) Black Faux Leather (16) Black (11) Graphite Gray (41) Marine Blue (21) Parrot Green (71) Sandstone Tan (51)



C Shown with Optional Height-Adjustable T-Arms

Graphite Gray (41)



C Sandstone Tan (51)



Interval Series

Compact and comfortable—Ideal for all-day seating in tight spaces.

- Molded plastic, impact-resistant shell.
- Waterfall seat edge helps relieve pressure points on the underside of legs.
- Back height adjustment for optimal lumbar support.
- Optional Arms sold separately.
- Durable premium fabric upholstery designed to resist abrasions and fading.
- Manufacturer's limited five-year warranty.
- Meets or exceeds ANSI/BIFMA Standards.
- Contains 5% post-consumer recycled content, 30% total recycled content. Casters supplied with this chair are not suitable for all floor types.



ID No.	Color	Shpg. Wt.	Unit	Price
A SWIVEL/TILT TASK CHAIR				
Supports up to 250 lbs. Seat: 19 $\frac{7}{8}$ " × 18 $\frac{1}{4}$ ". Back: 16 $\frac{1}{2}$ " × 17 $\frac{3}{8}$ ". Overall height: 34 $\frac{7}{8}$ " to 39 $\frac{1}{2}$ ".				
Leather				
1	ALE-IN4819	Black	31 lbs.	Each 200.00
Fabric				
2	ALE-IN4811	Black	31 lbs.	Each 190.00
3	ALE-IN4841	Graphite Gray	31 lbs.	Each 190.00
4	ALE-IN4821	Marine Blue	31 lbs.	Each 190.00
5	ALE-IN4871	Parrot Green	31 lbs.	Each 190.00
6	ALE-IN4851	Sandstone Tan	31 lbs.	Each 190.00
B SWIVEL/TILT MESH CHAIR				
Supports up to 250 lbs. Seat: 19 $\frac{7}{8}$ " × 18 $\frac{1}{4}$ ". Back: 16 $\frac{1}{2}$ " × 17 $\frac{3}{8}$ ". Overall height: 34 $\frac{7}{8}$ " to 39 $\frac{1}{2}$ ".				
Leather				
7	ALE-IN4815	Black	28 lbs.	Each 209.00
Fabric				
8	ALE-IN4814	Black	28 lbs.	Each 199.00
9	ALE-IN4844	Graphite Gray	28 lbs.	Each 199.00
10	ALE-IN4824	Marine Blue	28 lbs.	Each 199.00
11	ALE-IN4874	Parrot Green	28 lbs.	Each 199.00
12	ALE-IN4854	Sandstone Tan	28 lbs.	Each 199.00

ID No.	Color	Shpg. Wt.	Unit	Price
--------	-------	-----------	------	-------

C | SWIVEL TASK STOOL
Adjustable footring for optimal feet positioning. Supports up to 250 lbs.
Seat: 19 $\frac{7}{8}$ " × 18 $\frac{1}{4}$ ". Back: 16 $\frac{1}{2}$ " × 17 $\frac{3}{8}$ ". Overall height: 40 $\frac{3}{4}$ " to 51 $\frac{1}{8}$ ".

Faux Leather				
13	ALE-IN4616	Black	36 lbs.	Each 260.00
Fabric				
14	ALE-IN4611	Black	36 lbs.	Each 260.00
15	ALE-IN4641	Graphite Gray	36 lbs.	Each 260.00
16	ALE-IN4621	Marine Blue	36 lbs.	Each 260.00
17	ALE-IN4651	Sandstone Tan	36 lbs.	Each 260.00

OPTIONAL HEIGHT-ADJUSTABLE T-ARMS
For Alera® Interval and Essentia Series Chairs. Help reduce strain on shoulders and neck. Adjustable for user's comfort. Easy installation. Soft PU Armcaps.

18 ALE-IN49AKA10B Black Pair 70.00

OPTIONAL FIXED HEIGHT T-ARMS
For Alera® Interval and Essentia Series Chairs. Stationary arms stay in place. Help reduce strain on neck and shoulders. Attach with ease. Soft PU Armcaps.

19 ALE-IN49AKB10B Black Pair 60.00

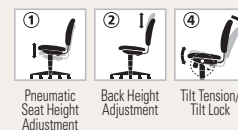

For more information on additional chair features see page 22.



A

Shown with Optional Height-Adjustable T-Arms

Blue (FA20)



Essentia Series

Contoured seat and back provide added comfort.

- Features back depth adjustment and rotates a full 360° in either direction for ease of motion.
- Black five-star base with casters.
- Optional Arms sold and shipped separately.
- Manufacturer's limited five-year warranty.
- Meets or exceeds ANSI/BIFMA Standards. 



B

Shown with Optional Height-Adjustable T-Arms

Burgundy (FA30)



B

Shown with Optional Fixed T-Arms

Gray (FA40)

ID No.	Color	Shpg. Wt.	Unit	Price
A SWIVEL TASK CHAIR				
Supports up to 250 lbs. Seat: 19¼" × 18½". Back: 17⅞" × 18½". Overall height: 36" to 41⅞". ① ③				
1	ALE-VT48FA10B	Black	28 lbs.	Each 160-00
2	ALE-VT48FA20B	Blue	28 lbs.	Each 160-00
3	ALE-VT48FA30B	Burgundy	28 lbs.	Each 160-00
4	ALE-VT48FA40B	Gray	28 lbs.	Each 160-00

B SWIVEL TASK CHAIR WITH ADJUSTABLE ARMS

Supports up to 250 lbs.
Seat: 19¼" × 18½". Back: 17⅞" × 18½". Overall height: 36" to 41⅞". ① ③

5	ALE-VTA4810	Black	36 lbs.	Each 220-00
OPTIONAL HEIGHT-ADJUSTABLE T-ARMS				
For Alera® Interval and Essentia Series Chairs. Help reduce strain on shoulders and neck. Adjustable for user's comfort. Easy installation. Soft PU Armcaps.				
6	ALE-IN49AKA10B	Black	Pair	70-00
OPTIONAL FIXED HEIGHT T-ARMS				
For Alera® Interval and Essentia Series Chairs. Stationary arms stay in place. Help reduce strain on neck and shoulders. Attach with ease. Soft PU Armcaps.				
7	ALE-IN49AKB10B	Black	Pair	60-00

Essentia Series

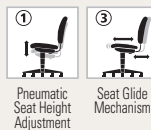
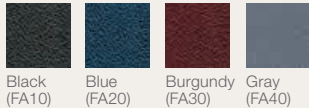

For more information on additional chair features see page 22.

17-AL-L-A3L

Seating Big & Tall

Maxxis Series



Black Leather

Ravino Series



Black Leather



A **new**



B



C



Maxxis Big and Tall Series

Make a statement with this ultra comfortable and cushioned chair for the big and tall user.

- Luxurious leather upholstery, mattress-like coil springs, and modern gel-cooling pads to keep the user cool and comfortable all day long.
- Unique gel cooling pad technology under the upholstery provides instant even cooling.
- Coil spring technology in the seat further enhances the sitting experience for a more mattress-like support.
- Heavy duty chrome base and mechanism are reinforced and help to evenly distribute weight.
- Ultra padded armrest, headrest and bolsters.
- Waterfall seat edge helps to reduce pressure points at the back of the knee.
- Manufacturer's limited five-year warranty.
- Meets or exceeds ANSI/BIFMA Standards.

ID No. Color Shpg. Wt. Unit Price

ID No.	Color	Shpg. Wt.	Unit	Price
A LEATHER CHAIR				
Supports up to 500 lbs.				
Seat: 25 1/8" x 21 1/4". Back: 24" x 33". Overall height: 44 7/8" to 48 5/8".				
1	ALE-MS4419	Black	68 lbs.	Each 659.00



See more Alera products at www.aleradetails.com

Ravino Big and Tall Series

Designed to provide maximum support and comfort to the big and tall user.

- Plush pillow-top seat and back for comfort.
- Open-loop aluminum arms with padded armrests.
- Soft black leather upholstery.
- Chrome-plated five-star base with nylon casters for easy mobility.
- Manufacturer's limited five-year warranty.
- Meets or exceeds ANSI/BIFMA Standards.

ID No. Color Shpg. Wt. Unit Price

ID No.	Color	Shpg. Wt.	Unit	Price
B HIGH-BACK BIG AND TALL SWIVEL/TILT LEATHER CHAIR				
Supports up to 450 lbs.				
Seat: 22 7/8" x 21 3/4". Back: 22" x 31". Overall height: 42 7/8" to 46".				
2	ALE-RV44LS10C	Black	73 lbs.	Each 649.00
C MID-BACK BIG AND TALL SWIVEL/TILT LEATHER CHAIR				
Supports up to 450 lbs.				
Seat: 22 7/8" x 21 3/4". Back: 22" x 28 3/4". Overall height: 38 5/8" to 41 5/8".				
3	ALE-RV45LS10C	Black	69 lbs.	Each 619.00



For more information on additional chair features see page 22.

Mota Series



Black

Merix450 Series



Black Mesh



Mota Big and Tall Series

Generously padded contoured seating ideal for the big and tall user.

- Reinforced seating structure and steel base for maximum reliable support.
- Enhanced padding and fabrics for extra support all-day long.
- Height-adjustable soft-padded T-arms for optimal arm positioning.
- Waterfall seat edge reduces pressure points at the back of the knees.
- Manufacturer's limited five-year warranty.
- Contains 5% post-consumer recycled content, 30% total recycled content.
- Meets or exceeds ANSI/BIFMA Standards.

ID No.	Color	Shpg. Wt.	Unit	Price
--------	-------	-----------	------	-------

A BIG AND TALL CHAIR

Supports up to 450 lbs.

Seat: 23 1/4" x 22". Back: 23 5/8" x 24 1/2". Overall height: 41 3/4" to 45 1/4".

1	ALE-MT4510	Black	54 lbs.	Each	509.00
---	------------	-------	---------	------	--------

B BIG AND TALL STOOL

Welded integrated footring for leg support. Supports up to 450 lbs.

Seat: 23 5/8" x 21". Back: 22" x 21 1/4". Overall height: 41 3/4" to 49 1/4".

2	ALE-MT4610	Black	65 lbs.	Each	609.00
---	------------	-------	---------	------	--------



Merix450 Series Mesh Big and Tall Chair

Aesthetically stylish for superior sitting experience for users up to 450 lbs.

- Breathable fabric mesh back with super cushioned mesh fabric seat.
- Integrated lumbar support encourages ideal back posture.
- Manufacturer's limited five-year warranty.
- Meets or exceeds ANSI/BIFMA Standards.

ID No.	Color	Shpg. Wt.	Unit	Price
--------	-------	-----------	------	-------

C MID-BACK SWIVEL/TILT CHAIR

Supports up to 450 lbs.

Seat: 23 1/4" x 20 7/8". Back: 19 5/8" x 26 3/4". Overall height: 39 1/8" to 42 3/4".

3	ALE-MX4517	Black	53 lbs.	Each	539.00
---	------------	-------	---------	------	--------



See more Alera products at www.aleradetails.com



For more information on additional chair features see page 22.

Seating Big & Tall



XL Series Big & Tall Chairs

A fusion of remarkable style and exceptional ergonomics for larger individuals up to 500 lbs.

- Smartly engineered wrap-frame construction redistributes user weight through the chair for maximum strength and durability.
- Plush sculptured seat and back are ideal for the plus-size user.
- Contoured stitched upholstery and custom-designed back strap for superior aesthetics.
- Reinforced high-strength base with casters/glides.
- Manufacturer's limited five-year warranty.
- Meets or exceeds ANSI/BIFMA Standards.

ID No.	Color	Shpg. Wt.	Unit	Price
A BIG & TALL HIGH-BACK TASK CHAIR				
Supports up to 500 lbs. Seat: 22" x 20 3/4". Back: 22" x 22 1/2". Seat height range: 17 1/2" to 21".				
1	AAP-CP110	Black	55 lbs.	Each 549.00
B BIG & TALL MID-BACK TASK CHAIR				
Supports up to 500 lbs. Seat: 22" x 20 3/4". Back: 22" x 19 1/2". Seat height range: 17 1/2" to 21".				
2	AAP-CP210	Black	53 lbs.	Each 489.00
C BIG & TALL MID-BACK GUEST CHAIR				
Supports up to 450 lbs. Seat: 22" x 20 3/4". Back: 22" x 18". Seat height: 18".				
3	AAP-CP310	Black	48 lbs.	Each 359.00



Pneumatic Seat Height Adjustment



Tilt Tension/Tilt Lock

For more information on additional chair features see page 22.



Oversize Stack Chairs

Heavy-duty chair with built-in lumbar support is designed to accommodate larger guests.

- Extra-wide seat with waterfall edge has a 3 1/2" foam cushion for all-day comfort.
- Durable 18 gauge, 1" steel frame with front and back stretcher bars for added strength.
- Stacks up to 5 high for space-efficient storage.
- Great for healthcare facilities, dining halls, guest seating or any multi-use application where comfort and durability are needed.
- Two chairs per carton.
- Manufacturer's limited five-year warranty.
- Contains 30% post-consumer recycled content, 30% total recycled content.
- Meets or exceeds ANSI/BIFMA Standards.

ID No.	Color	Shpg. Wt.	Unit	Price
D OVERSIZE STACK CHAIR WITH FIXED PADDED ARMS				
Supports up to 500 lbs. Seat: 20 1/2" x 15 1/2". Back: 20" x 19 3/4". Overall height: 35 1/2".				
Vinyl				
4	ALE-BT6516	Black	50 lbs.	Carton 575.00
Fabric				
5	ALE-BT6510	Black	50 lbs.	Carton 575.00
6	ALE-BT6520	Navy	50 lbs.	Carton 575.00
E OVERSIZE STACK CHAIR WITHOUT ARMS				
Supports up to 500 lbs. Seat: 20 1/2" x 15 1/2". Back: 20" x 19 3/4". Overall height: 35 1/2".				
Vinyl				
7	ALE-BT6616	Black	46 lbs.	Carton 525.00
Fabric				
8	ALE-BT6610	Black	46 lbs.	Carton 525.00
9	ALE-BT6620	Navy	46 lbs.	Carton 525.00



Black



Black/
Black



Black/
Black



See more Alera products at www.aleradetails.com



D



Sorrento Series

Perfect for waiting areas, conference rooms or guest seating.

- Durable and stylish black faux leather upholstery is PVC-free.
- Cushioned seat and base with sturdy black straight steel legs.
- Stacks up to four high.
- Manufacturer's limited five-year warranty.
- Meets or exceeds ANSI/BIFMA Standards.

ID No.	Color	Shpg. Wt.	Qty.	Unit	Price
--------	-------	-----------	------	------	-------

A STACKING GUEST CHAIR

Supports up to 250 lbs. Seat: 19" x 19". Back: 19" x 11 $\frac{1}{4}$ ". Overall height: 32 $\frac{1}{8}$ ".

1	ALE-UT6816	Black	46 lbs.	2	Carton	329.00
---	------------	-------	---------	---	--------	--------

Continental Series

An office essential!

- Convenient, space-saving chairs stack up to twelve high when not in use.
- Padded seat and back with durable acrylic upholstery for comfort and long wear.
- Designed for comfort with a waterfall seat and contoured back.
- Stacks up to five high.
- Sturdy black tubular steel frame for strength and stability.
- Manufacturer's limited five-year warranty.
- Meets or exceeds ANSI/BIFMA Standards. 

ID No.	Color	Shpg. Wt.	Qty.	Unit	Price
--------	-------	-----------	------	------	-------

B STACKING GUEST CHAIR

Supports up to 250 lbs. Seat: 18 $\frac{7}{8}$ " x 16 $\frac{3}{4}$ ". Back: 19 $\frac{5}{8}$ " x 13 $\frac{3}{4}$ ". Overall height: 30 $\frac{3}{8}$ ".

2	ALE-SC67FA10B	Black	69 lbs.	4	Carton	489.00
---	---------------	-------	---------	---	--------	--------

Continental Series Stacking Chairs

Stacks up to 12 high.

- Padded seat and back with vinyl upholstery.
- Four chairs per carton.
- Manufacturer's limited five-year warranty.
- Meets or exceeds ANSI/BIFMA Standards.

ID No.	Color	Shpg. Wt.	Qty.	Unit	Price
--------	-------	-----------	------	------	-------

C VINYL STACKING CHAIRS

Supports up to 250 lbs. Seat: 15 $\frac{3}{4}$ " x 15 $\frac{3}{4}$ ". Back: 13" x 12 $\frac{3}{4}$ ". Overall height: 32 $\frac{3}{8}$ ".

3	ALE-SC68VY10B	Black	62 lbs.	4	Carton	449.00
---	---------------	-------	---------	---	--------	--------

Stacking Chair Dolly

- Sturdy steel powder coated dolly with $\frac{3}{4}$ " raised edge keeps chairs from sliding off.
- Four casters.
- Holds 10-12 chairs.
- 22 $\frac{1}{2}$ "W x 22 $\frac{1}{2}$ "D.

ID No.	Color	Shpg. Wt.	Unit	Price
--------	-------	-----------	------	-------

D STACKING CHAIR DOLLY

4	ALE-SCCART	Black	14 lbs.	Each	99.00
---	------------	-------	---------	------	-------

Prices subject to change without notice.
Visit our website for the latest pricing and product information.

Seating Stacking



Black

Black/
Black



B

Black/
Black



C

Black/
Black



D

Charcoal
Gray



new

E



ES Series

Stylish modern seating for any workplace.

- Richly padded seats for all day support and comfort.
- Knit mesh back provides lumbar support and breathability.
- Durable steel frame and plastic molded arms.
- Manufacturer's limited five-year warranty.
- Contains 5% post-consumer recycled content, 30% total recycled content.
- Meets or exceeds ANSI/BIFMA Standards.

ID No.	Color	Shpg. Wt.	Qty.	Unit	Price
A MESH STACK CHAIR					
Stacks up to four high (two chairs per carton). Fully assembled. Supports up to 250 lbs. Seat: 20 $\frac{1}{8}$ " x 19 $\frac{3}{4}$ ". Back: 17 $\frac{3}{4}$ " x 16 $\frac{1}{2}$ ". Overall height: 34 $\frac{1}{4}$ ".					
1	ALE-ES4314	Black	60 lbs.	2	Carton 505.00

Mesh Guest Stacking Chair

- Great for use as guest seating or in training rooms.
- Includes both casters for mobility and glides for fixed use.
- Stacks up to five high.
- Manufacturer's limited five-year warranty.
- Contains 5% post-consumer recycled content, 20% total recycled content.
- Meets or exceeds ANSI/BIFMA Standards.

ID No.	Color	Shpg. Wt.	Unit	Price
B MESH GUEST STACKING CHAIR				
Supports up to 250 lbs. Seat: 18 $\frac{1}{8}$ " x 18 $\frac{1}{8}$ ". Back: 20 $\frac{7}{8}$ " x 17 $\frac{3}{4}$ ". Overall height: 36 $\frac{1}{4}$ ".				
2	ALE-EL4314	Black	23 lbs.	Each 305.00

Eikon Series

Contemporary breathable, vented back.

- Contoured mesh back for lumbar support with cushioned mesh seat.
- Durable steel frame with textured matte black finish.
- Great for use as guest seating or in training rooms.
- Includes both glides for fixed use or casters for mobility.
- Fully assembled.
- Stacks up to four high (two chairs per carton).
- Manufacturer's limited five-year warranty.
- Meets or exceeds ANSI/BIFMA Standards.

ID No.	Color	Shpg. Wt.	Qty.	Unit	Price
C EIKON SERIES STACKING MESH GUEST CHAIR					
Supports up to 250 lbs. Seat: 18 $\frac{1}{2}$ " x 18 $\frac{1}{2}$ ". Back: 17 $\frac{3}{4}$ " x 11 $\frac{1}{4}$ ". Overall height: 33 $\frac{1}{2}$ ".					
3	ALE-EK43ME10B	Black	40 lbs.	2	Carton 455.00

Continental Series

A smart stack chair for the office, conference room, auditorium or breakroom.

- Modern molded plastic chair with durable metal frame withstands heavy use, resists scratching and denting. Easy to clean.
- Flexi back adjusts for comfort based on user weight and provides lumbar support.
- Stacks neatly up to 12 high (four chairs per carton).
- Fully assembled.
- Manufacturer's limited five-year warranty.
- Meets or exceeds ANSI/BIFMA Standards.

ID No.	Color	Shpg. Wt.	Qty.	Unit	Price
D PLASTIC PERFORATED BACK STACK CHAIR					
Supports up to 250 lbs. Seat: 16 $\frac{1}{8}$ " x 17 $\frac{3}{4}$ ". Back: 17 $\frac{3}{8}$ " x 15 $\frac{1}{8}$ ". Overall height: 31 $\frac{1}{2}$ ".					
4	ALE-SC6546	Charcoal Gray	47 lbs.	4	Carton 519.00

E HIGH-DENSITY STACKING CHAIR CART

High-density stacking chair cart for quick storage and setup. Stacks up to 25 high-density stacking chairs. Sturdy heavy-duty frame and casters (2 locking) for easy mobility on any surface. Manufacturer's limited five-year warranty. Contains 55% post-consumer recycled content, 95% total recycled content. Meets or exceeds ANSI/BIFMA standards.

ID No.	Finish	W x D x H	Shpg. Wt.	Unit	Price
5	ALE-HDCART	Black	16 $\frac{1}{8}$ " x 22 $\frac{1}{2}$ " x 20 $\frac{3}{4}$ "	23 lbs.	Each 199.00



Black/Gray



Black/Gray



Nesting



Black/Gray



Stacking



Flex Back Nesting Chairs

Flexible, comfortable and stylish.

- Ideal for training, conference room and collaborative environments.
- Flexible mesh back with locking and unlocking feature provides flexibility and comfort.
- T-Pad arms for improved posture and support.
- Contoured seat with plush foam provides superior ergonomics.
- Nests densely for easy storage.
- Easy rolling casters provide instant mobility.
- Manufacturer's limited five-year warranty.
- Meets or exceeds ANSI/BIFMA Standards.



SL Series

Appealing aesthetics and versatile design—ideal for everything from conference rooms to breakrooms.

- Innovative chair design can either nest or stack for storage when not in use.
- Generously sized seat with padded cushion and ergonomic back encourages proper posture.
- Strong powder coated steel frame with casters.
- Nests or stacks up to 12 high (two per carton).
- Fully-assembled.
- Manufacturer's limited five-year warranty.
- Contains 20% post-consumer recycled content, 20% total recycled content.
- Meets or exceeds ANSI/BIFMA Standards.

ID No.	Color	Shpg. Wt.	Qty.	Unit	Price
A FLEX BACK NESTING CHAIR					
Supports up to 250 lbs. Seat: 18¾" × 17". Back: 17" × 13". Overall height: 34".					
1	AAP-FL274	Black	45 lbs.	2	Carton 710.00

ID No.	Color	Shpg. Wt.	Qty.	Unit	Price
B NESTING STACK CHAIR WITH ARMS					
Gang, nest or stack chairs together for use in reception or waiting areas. Supports up to 250 lbs. Seat: 17¾" × 16½". Back: 20½" × 11½". Overall height: 33½".					
2	AAP-SL652	Black	39 lbs.	2	Carton 449.00
C NESTING STACK CHAIR WITHOUT ARMS					
Gang, nest or stack chairs together for use in reception or waiting areas. Supports up to 250 lbs. Seat: 17¾" × 16½". Back: 20½" × 11½". Overall height: 33½".					
3	AAP-SL651	Black	35 lbs.	2	Carton 369.00

17-AL-L-A3L

Prices subject to change without notice. Visit our website for the latest pricing and product information.

Seating Stools

Interval Series



Black Faux Leather (16)

Black (11)

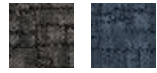

Graphite Gray (41)

Marine Blue (21)



Sandstone (51)



A

Sandstone (51)



B

Black

new



C

Black



D

Black



Interval Series

Compact and comfortable—ideal for all-day seating in tight spaces.

- Molded plastic, impact-resistant shell.
- Waterfall seat edge helps relieve pressure points on the underside of legs.
- Back height adjustment for optimal lumbar support.
- Optional arms sold separately.
- Manufacturer's limited five-year warranty.
- Meets or exceeds ANSI/BIFMA standards.

ID No.	Color	Shpg. Wt.	Unit	Price
--------	-------	-----------	------	-------

A SWIVEL TASK STOOL

Adjustable footring for optimal feet positioning. Supports up to 250 lbs. Seat: 19 $\frac{1}{8}$ " x 18 $\frac{1}{4}$ ". Back: 16 $\frac{1}{2}$ " x 17 $\frac{1}{8}$ ". Overall height: 40 $\frac{3}{4}$ " to 51 $\frac{1}{8}$ ".

Faux Leather

1	ALE-IN4616	Black	36 lbs.	Each	260.00
---	------------	-------	---------	------	--------

Fabric

2	ALE-IN4611	Black	36 lbs.	Each	260.00
3	ALE-IN4641	Graphite Gray	36 lbs.	Each	260.00
4	ALE-IN4621	Marine Blue	36 lbs.	Each	260.00
5	ALE-IN4651	Sandstone	36 lbs.	Each	260.00

OPTIONAL HEIGHT-ADJUSTABLE T-ARMS

For Alera® Interval and Essentia Series Chairs. Help reduce strain on shoulders and neck. Adjustable for user's comfort. Easy installation. Soft PU Armcaps.

6	ALE-IN49AKA10B	Black	Pair	70.00
---	----------------	-------	------	-------

OPTIONAL FIXED HEIGHT T-ARMS

For Alera® Interval and Essentia Series Chairs. Stationary arms stay in place. Help reduce strain on neck and shoulders. Attach with ease. Soft PU Armcaps.

7	ALE-IN49AKB10B	Black	Pair	60.00
---	----------------	-------	------	-------



Etros Series

An economical choice for mesh comfort.

- Breathable mesh back with cushioned mesh fabric seat.
- Adjustable lumbar support.
- Five-star base with casters for easy mobility.
- Manufacturer's limited five-year warranty.
- Contains 5% post-consumer recycled content, 30% total recycled content.
- Meets or exceeds ANSI/BIFMA standards.

ID No.	Color	Shpg. Wt.	Unit	Price
--------	-------	-----------	------	-------

B ETROS SERIES MESH STOOL

Supports up to 250 lbs. Height adjustable footring for optimal foot positioning. Seat: 20 $\frac{1}{4}$ " x 20 $\frac{1}{2}$ ". Back: 19" x 21 $\frac{1}{4}$ ". Overall height: 44 $\frac{1}{4}$ " to 54 $\frac{1}{8}$ ".

8	ALE-ET4614	Black	40 lbs.	Each	349.00
---	------------	-------	---------	------	--------



Elusion™ Series

Clean, classic styling complements the busy office environment.

- Contoured seat cushion with waterfall edge to help relieve pressure on legs.
- Height- and width-adjustable arms with soft polyurethane pads.
- Five-star base with casters for easy mobility.
- Breathable mesh back for all day support.
- Height adjustable ratchet back for optimal lumbar support.
- Manufacturer's limited five-year warranty.
- Contains 5% post-consumer recycled content, 15% total recycled content.
- Meets or exceeds ANSI/BIFMA standards.

ID No.	Color	Shpg. Wt.	Unit	Price
--------	-------	-----------	------	-------

C MESH STOOL

Ergonomically designed stool adjusts to fit multiple users. Adjustable foot ring for leg support. Supports up to 250 lbs.

Seat: 20 $\frac{1}{2}$ " x 21". Back: 20 $\frac{1}{8}$ " x 20 $\frac{1}{8}$ ". Overall height: 42 $\frac{1}{8}$ " to 51 $\frac{1}{8}$ ".

9	ALE-EL4614	Black	53 lbs.	Each	505.00
---	------------	-------	---------	------	--------



Mota Big and Tall Series

Generously padded contoured seating ideal for the big and tall user.

- Reinforced seating structure and steel base for maximum reliable support.
- Enhanced padding and fabrics for extra support all-day long.
- Height-adjustable soft-padded T-arms for optimal arm positioning.
- Waterfall seat edge reduces pressure points at the back of the knees.
- Manufacturer's limited five-year warranty.
- Contains 5% post-consumer recycled content, 30% total recycled content.
- Meets or exceeds ANSI/BIFMA standards.

ID No.	Color	Shpg. Wt.	Unit	Price
--------	-------	-----------	------	-------

D BIG AND TALL STOOL

Welded integrated footring for leg support. Supports up to 450 lbs.

Seat: 23 $\frac{3}{8}$ " x 21". Back: 22" x 21 $\frac{1}{4}$ ". Overall height: 45 $\frac{5}{8}$ " to 49 $\frac{1}{4}$ ".

10	ALE-MT4610	Black	65 lbs.	Each	609.00
----	------------	-------	---------	------	--------



1 Pneumatic Seat Height Adjustment



2 Back Height Adjustment



3 Integral Lumbar Support

For more information on additional chair features see page 22.



A

Black



B



C



WL Series

Perfect for workbench, service desk and work table use in industrial, commercial and educational environments.

- Generously sized height adjustable seat with waterfall contours for maximum comfort and ergonomics.
- Large contoured back is adjustable up, down, in and out
- Wipe-friendly seat and back protects from spills and facilitates easy maintenance.
- Self sealing seat and back material reduces wear and extends product life.
- Manufacturer's limited five-year warranty.
- Meets or exceeds ANSI/BIFMA standards.

ID No.	Color	Shpg. Wt.	Unit	Price
--------	-------	-----------	------	-------

A WL WORKBENCH STOOL

Agile design delivers unique ergonomics. Soft cushion seat and back maximizes comfort. Reinforced structural inserts for seat and back assures durability. Oversized paddle activated lift allows user to set desired seat height within seconds. Heavy density nylon base provides stability. Supports up to 250 lbs.

Seat: 16" x 16". Back: 15" x 12½". Seat height: 17¼" to 25". ① ②

1	AAP-CS616	Black	28 lbs.	Each	309.00
---	-----------	-------	---------	------	-------------------



D



HL Series Stools

Anti-microbial upholstered seat and chrome plated steel frame delivers a wipe friendly stool.

- Contemporary styling and advanced ergonomics for healthcare, laboratory, educational or task environments.
- Easy activation handle for seat height adjustment.
- Dual back bar for maximum support.
- Dual wheel hooded casters for mobility.
- Manufacturer's limited five-year warranty.
- Meets or exceeds ANSI/BIFMA standards.

ID No.	Color	Shpg. Wt.	Unit	Price
--------	-------	-----------	------	-------

C HEIGHT-ADJUSTABLE STOOL WITH BACK

Supports up to 300 lbs. Seat: 16" dia. Back: 12" x 6½". Overall height: 30" to 34". ① ③

3	AAP-CS610	Black	25 lbs.	Each	359.00
---	-----------	-------	---------	------	-------------------

D HEIGHT-ADJUSTABLE STOOL

Supports up to 300 lbs. Seat: 16" dia. Seat height: 18" to 24". ①

4	AAP-CS614	Black	20 lbs.	Each	249.00
---	-----------	-------	---------	------	-------------------



For more information on additional chair features see page 22.



Height-Adjustable Utility Stool

- Easy ring-activated height adjustment anywhere you reach.
- Easy to clean antimicrobial upholstery.
- Manufacturer's limited five-year warranty.
- Contains 5% post-consumer recycled content, 30% total recycled content.
- Meets or exceeds ANSI/BIFMA standards.

ID No.	Color	Shpg. Wt.	Unit	Price
--------	-------	-----------	------	-------

B HEIGHT-ADJUSTABLE UTILITY STOOL

Supports up to 250 lbs. Seat: 18¼" dia. Overall height: 22" to 29½". ①

2	ALE-US4616	Black	23 lbs.	Each	150.00
---	------------	-------	---------	------	-------------------

17-AL-L-A3L

Computer Furniture Stools

Sit-to-Stand Perch Stool



Gray (GR) Blue (BU) Black (BK)

Balance Perch Stool



Red (RD) Blue (BU) Black (BK)



Perch Series

Advanced active ergonomics goes from sitting to standing with ease.

- Pivoting angled column moves with the body for constant alignment.
- Great for perching for fast tasks or lean back and sit for more intensive focused work.
- Goes from sitting height to standing height.
- Auto return swivel seat moves with the body as you twist, and returns to front automatically when you get up.
- Wide boomerang base for stability when leaning far forward.
- Manufacturer's limited five-year warranty.
- Meets or exceeds ANSI/BIFMA Standards.



ID No.	Color	Shpg. Wt.	Unit	Price
--------	-------	-----------	------	-------

A SIT-TO-STAND PERCH STOOL

Supports up to 250 lbs. Seat: 14 $\frac{1}{4}$ " x 13 $\frac{3}{4}$ ". Overall height: 24 $\frac{3}{4}$ " to 33 $\frac{3}{4}$ ". ^①

Black Base

1	ALE-AE35PSBK	Black	18 lbs.	Each	299.00
2	ALE-AE35PSBU	Blue	18 lbs.	Each	299.00
3	ALE-AE35PSGR	Gray	18 lbs.	Each	299.00

Silver Base

4	ALE-AE36PSBK	Black	18 lbs.	Each	299.00
5	ALE-AE36PSBU	Blue	18 lbs.	Each	299.00
6	ALE-AE36PSGR	Gray	18 lbs.	Each	299.00

Balance Perch Stool

Lightweight, mobile frame is easy to move.

- Waterfall seat edge increases ergonomic comfort.
- Simple one-touch height adjustment.
- Full 360-degree range of motion.
- Extra wide handle provides a confident grip.
- Manufacturer's limited five-year warranty.
- Meets or exceeds ISTA Standards.

ID No.	Color	Shpg. Wt.	Unit	Price
--------	-------	-----------	------	-------

B BALANCE PERCH STOOL

Supports up to 250 lbs. Overall height: 22 $\frac{1}{2}$ " to 33 $\frac{3}{4}$ ". ^①

Black Base

7	ALE-AE33PSBK	Black	20 lbs.	Each	349.00
8	ALE-AE33PSBU	Blue	20 lbs.	Each	349.00
9	ALE-AE33PSRD	Red	20 lbs.	Each	349.00

White Base

10	ALE-AE34PSBK	Black	20 lbs.	Each	349.00
11	ALE-AE34PSBU	Blue	20 lbs.	Each	349.00
12	ALE-AE34PSRD	Red	20 lbs.	Each	349.00



Pneumatic Seat Height Adjustment

For more information on additional chair features see page 22.

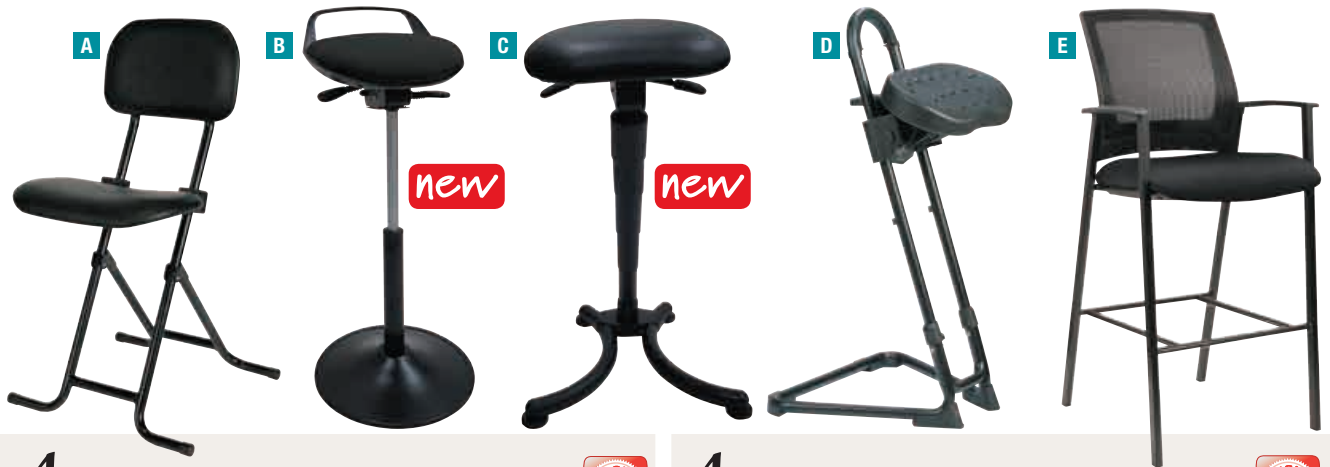

IL Series

Innovative design elements embodied in steel construction.

- Perfect for workbench, service desk and work table use in industrial, commercial and educational environments.
- Tools-free seat height adjustment in a 10" range.
- Foldable for fast set-up and compact storage.
- Clever sit-to-stand ergonomics to enhance productivity.
- Wipe-friendly vinyl upholstered seat and back facilitates easy maintenance.
- Non-marring rubber sleeved legs ensure stability.
- Manufacturer's limited five-year warranty.
- Contains 30% post-consumer recycled content, 30% total recycled content.
- Meets or exceeds ANSI/BIFMA standards.

ID No.	Color	Shpg. Wt.	Unit	Price
--------	-------	-----------	------	-------

A HEIGHT-ADJUSTABLE FOLDING STOOL

Supports up to 300 lbs. Seat: 16" x 10½". Back: 14" x 9". Seat height: 17½" to 27½".

1	AAP-CS612	Black	20 lbs.	Each	199.00
---	-----------	-------	---------	------	-------------------

Perch Sit Stool Series

Comfortable, stylish and adjustable.

- Plush comfortable seat with tilt feature allows user to perch in a dynamic work position.
- Seat height range suitable for adjustable workbench, desk and counter applications.
- Ready to reach handles for hassle-free adjustment.
- Built-in handle for portability.
- Round steel base provides reliable and firm support.
- Manufacturer's limited five-year warranty.
- Meets or exceeds ANSI/BIFMA Standards.

ID No.	Color	Shpg. Wt.	Unit	Price
--------	-------	-----------	------	-------

B PERCH SIT STOOL

Supports up to 250 lbs. Seat: 14" x 14". Overall height: 25¼" to 35½". ^①

2	AAP-S0600	Black	22 lbs.	Each	199.00
---	-----------	-------	---------	------	-------------------



For more information on additional chair features see page 22.

Pneumatic Seat Height Adjustment



Lean-In Sit/Stand Stool Series

Innovative, interactive and comfortable.

- Inclined lift position allows for dynamic postures needed for various tasks.
- Plush generously sized seat allows maximum comfort.
- Ready to reach handles for hassle-free adjustment.
- Arc shaped steel frame provides superior strength and support.
- Built-in rollers assure easy portability.
- Manufacturer's limited five-year warranty.
- Meets or exceeds ANSI/BIFMA Standards.

ID No.	Color	Shpg. Wt.	Unit	Price
--------	-------	-----------	------	-------

C LEAN-IN SIT/STAND STOOL

Supports up to 250 lbs. Seat: 15¾" x 12". Overall height: 24" to 33". ^①

3	AAP-ST601	Black	22 lbs.	Each	309.00
---	-----------	-------	---------	------	-------------------

SS Series

Designed to deliver the comfort of sitting even when standing.

- Seat adjusts to accommodate perch positioning.
- Tear/poke resistant and wipe-friendly seat facilitates easy maintenance.
- Non-marring rubber padded base assures stability.
- Manufacturer's limited five-year warranty.
- Meets or exceeds ANSI/BIFMA Standards.

ID No.	Color	Shpg. Wt.	Unit	Price
--------	-------	-----------	------	-------

D SIT/STAND ADJUSTABLE STOOL

Supports up to 300 lbs. Seat: 14" x 8½". 23½" to 33½".

4	AAP-SS600	Black	26 lbs.	Each	339.00
---	-----------	-------	---------	------	-------------------



ES Series

Stylish modern seating for any workplace.

- Richly padded seats for all day support and comfort.
- Knit mesh back provides lumbar support and breathability.
- Durable steel frame and plastic molded arms.
- Manufacturer's limited five-year warranty.
- Contains 5% post-consumer recycled content, 30% total recycled content.
- Meets or exceeds ANSI/BIFMA standards.

ID No.	Color	Shpg. Wt.	Qty.	Unit	Price
--------	-------	-----------	------	------	-------

E ES SERIES MESH STOOL

A modern mesh stool perfect for hospitality and workbench settings. Two chairs per carton. Supports up to 250 lbs. Seat: 20½" x 19¾". Back: 17¾" x 16½". Overall height: 46¾".

5	ALE-ES4614	Black	79 lbs.	2	Carton	555.00
---	------------	-------	---------	---	--------	-------------------

Prices subject to change without notice. Visit our website for the latest pricing and product information.

Alera—engineered for high performance



Steel Folding Chairs

An office necessity!

- Sturdy tubular steel frame with double braced construction.
- Textured powder-coated finish resists smudges and fingerprints.
- Foot caps help protect flooring.
- Manufacturer's limited five-year warranty.
- Meets or exceeds ANSI/BIFMA Standards.

ID No.	Color	Shpg. Wt.	Qty.	Unit	Price
--------	-------	-----------	------	------	-------

A STEEL FOLDING CHAIR

Supports up to 350 lbs. Seat: 15¾" x 15½". Back: 18" x 13½". Overall height: 30½".

All-Steel—Easy to clean and long lasting.

1	ALE-FC94B	Graphite	46 lbs.	4	Carton	180.00
2	ALE-FC94LG	Light Gray	46 lbs.	4	Carton	180.00
3	ALE-FC94T	Tan	46 lbs.	4	Carton	180.00

With Vinyl Padded Seat

4	ALE-FC94VY10B	Graphite	48 lbs.	4	Carton	210.00
5	ALE-FC94VY40LG	Light Gray	48 lbs.	4	Carton	210.00
6	ALE-FC94VY50T	Tan	48 lbs.	4	Carton	210.00

With Vinyl Padded Seat and Back

7	ALE-FC96B	Graphite	50 lbs.	4	Carton	220.00
8	ALE-FC96G	Light Gray	50 lbs.	4	Carton	220.00
9	ALE-FC96T	Tan	50 lbs.	4	Carton	220.00

With Fabric Padded Seat and Back

10	ALE-FC97B	Graphite	51 lbs.	4	Carton	230.00
11	ALE-FC97G	Light Gray	51 lbs.	4	Carton	230.00
12	ALE-FC97T	Tan	51 lbs.	4	Carton	230.00





Resin Folding Chairs

Molded plastic folding chair is perfect for quick setups with large groups.

- Contoured seat and back for ergonomic comfort.
- Great for indoor and outdoor use.
- Heavy-duty steel and black anthracite powder coat finish resists corrosion and provides exceptional strength.
- Steel seat ring and double U-braces for stability and weight bearing which also prevents racking.
- Folds flat for compact storage.
- Top handle for easy grab and go, set-up and take-down.
- Manufacturer's limited five-year warranty.
- Meets or exceeds ANSI/BIFMA Standards.

ID No.	Color	Shpg. Wt.	Qty.	Unit	Price
--------	-------	-----------	------	------	-------

A MOLDED RESIN FOLDING CHAIR

Supports up to 250 lbs. Seat: 15" × 15¾". Back: 17½" × 13". Overall height: 34¼".

1	ALE-FR9402	White	36 lbs.	4	Carton	295.00
---	------------	-------	---------	---	--------	--------

Economy Resin Folding Chairs

The practical option to create instant seating anywhere.

- Great for indoor and outdoor use.
- Lightweight resin plastic seat and back.
- Sturdy steel base frame with black anthracite powder-coat finish resists corrosion.
- Folds flat for compact storage.
- Non-marring caps protect surfaces from scratches.
- Manufacturer's limited five-year warranty.

ID No.	Color	Shpg. Wt.	Qty.	Unit	Price
--------	-------	-----------	------	------	-------

B ECONOMY RESIN FOLDING CHAIR

Supports up to 250 lbs. Seat: 15¾" × 15¾". Back: 17¾" × 6½". Overall height: 31½".

2	ALE-FR9502	White	32 lbs.	4	Carton	149.00
---	------------	-------	---------	---	--------	--------

Folding Chair/Table Cart

Adjustable to accommodate most styles of folding chairs/tables.

- Convenient steel construction cart can be used as both a folding chair cart or table cart.
- Adjustable U-bar keeps folding chairs from falling over during transport.
- U-bar is removable for table storage.
- Heavy-duty casters; two locking.
- Holds up to 600 lbs.
- Includes safety strap.
- Manufacturer's limited five-year warranty.

ID No.	Finish	W × D	Shpg. Wt.	Unit	Price
--------	--------	-------	-----------	------	-------

C FOLDING CHAIR/TABLE CART

3	ALE-FTCART	Black	20¾" × 50¾" to 75¾"	60 lbs.	Each	555.00
---	------------	-------	---------------------	---------	------	--------



Folding Chair

Blend of innovation, engineering and efficiency creates demonstrable distinction.

- Sleek frame with reinforced hinges allows to fold perfectly flat and delivering 50% increase in storage efficiency.
- Large high density polypropylene seat enclosed in a steel envelope creates comfort and firm support.
- Extra strength steel frame guarantees durability and rigidity.
- Heavy density nylon glides provides stability.
- Manufacturer's limited five-year warranty.
- Meets or exceeds ANSI/BIFMA Standards.

ID No.	Color	Shpg. Wt.	Qty.	Unit	Price
--------	-------	-----------	------	------	-------

D FOLDING CHAIR

Supports up to 300 lbs. Seat: 15" × 16¼". Back: 17" × 5½". Overall height: 30¼".

4	AAP-FC912	Black	37 lbs.	4	Carton	269.00
---	-----------	-------	---------	---	--------	--------

Prices subject to change without notice.
Visit our website for the latest pricing and product information.

Seating Foot Rests/Back Supports



A - G

new

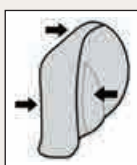

Unique material rebounds at pressure points to fully support back and waist



A SOFT CUSHIONED ERGONOMIC FOOTREST

Provides precise ergonomic foot support for any user. Comfortable cushioned footrest helps reduce strain on the feet. Non-slip anti-fatigue cushioned mat. Clever foot adjustable tilt mechanism. Two tilt positions at 20 and 40 degrees as well as two height-adjustable positions. Non-slip, non-scratching floor pads keep your footrest in place on the floor. Manufacturer's limited five-year warranty.

ID No.	W × D × H	Color	Unit	Price
1 ALE-FS112	14" × 19½" × 3¾" to 7½"	Black	Each	59.00

B RELAXING ADJUSTABLE FOOTREST

Provides precise ergonomic foot support for any user. Designed with roller surface bumps to both help massage tired feet and keep your foot from slipping. Three tilt positions from 20 to 70 degrees and three height-adjustable positions. Non-slip, non-scratching floor pads keep your footrest in place on the floor. Manufacturer's limited five-year warranty.

ID No.	W × D × H	Color	Unit	Price
2 ALE-FS212	13¾" × 17¾" × 4½" to 6¾"	Black	Each	39.00

C ERGO TILT FOOTREST

Tilting footrest for proper ergonomic alignment. Clever foot adjustable tilt mechanism rolls back and forth for your ideal angle from 0 to 20 degrees. Ribbed surface prevents feet from slipping. Non-slip, non-scratching floor pads keep your footrest in place on the floor. Manufacturer's limited five-year warranty.

ID No.	W × D × H	Color	Unit	Price
3 ALE-FS312	13¾" × 17¾" × 3¾" to 5¾"	Black	Each	29.00

D LUMBAR BACKREST

Convenient memory foam lumbar cushion provides support for the lower back. Mesh fabric upholstery is both cooling and long-lasting. Adjustable elastic strap secures the backrest just where you want it. Great with office chairs, car seats, or in the home. Manufacturer's limited five-year warranty.

ID No.	W × D × H	Color	Unit	Price
4 ALE-BR317 *	14¾" × 4¾" × 6¼"	Black	Each	35.00

* Contains 5% post-consumer recycled content, 10% total recycled content.

E MESH BACKREST

Ergonomically designed stretched mesh backrest supports the lower back. Contoured shape and curves to keep the back in alignment. Breathable mesh fabric keeps the back cool and supported. Adjustable elastic straps secure backrest in place. Great with office chairs, car seats, or in the home. Manufacturer's limited five-year warranty.

ID No.	W × D × H	Color	Unit	Price
5 ALE-BR118	18½" × 15¾" × 5¾"	Black	Each	29.00

F COOLING GEL MEMORY FOAM BACKREST AND SEAT CUSHION

Soft, resilient memory foam cushion is pressure sensitive to help relieve stress points. Smart gel-cooling layer helps provides longer lasting cooling by dissipating heat. Long-lasting, fade-resistant fabric cover. Washable. Manufacturer's limited five-year warranty.

ID No.	W × D × H	Color	Unit	Price
6 ALE-CGC411	14¾" × 14¾" × 2¾"	Black	Each	54.00

G SEAT CUSHION

Non-slip under cushion cover keeps the cushion firmly in place on your chair. Manufacturer's limited five-year warranty.

ID No.	W × D × H	Color	Unit	Price
7 ALE-CGC511	16½" × 15¾" × 2¾"	Black	Each	59.00

H DELUXE BACK SUPPORT

Provides complete support for back and spine. Unique polyurethane sponge material retains its shape and rebounds at pressure points for full support. Removable cover for easy cleaning. Adjustable straps hold cushion firmly to chair. Manufacturer's limited five-year warranty.

ID No.	W × D × H	Color	Unit	Price
8 ALE-BR210	15½" × 3" × 11"	Black	Each	41.79

Files

Conquer paperwork pileup with easy-access organization.



Organization is everything when it comes to streamlining your office and workflow. And despite all of the new technology, paper management is still one of the biggest challenges in every office. Tame the paper tiger with efficient filing that makes the most of your space. From practical backroom archives to sleek dual-purpose file/seating, we have what it takes to put paper in its place.

Lateral Files	64
Pedestal Files	65, 66
Mobile Files	67



Lateral Files

Drawers with side-to-side hangrails to accommodate letter/legal hanging files.

- Full drawer extension on steel ball bearing telescoping slide suspension.
- Stylish full-width radius edge recessed pulls.
- Anti-tipping interlock system allows only one drawer to open at a time.
- Single key core removable lock with two keys.
- Manufacturer's limited five-year warranty.
- Contains 23% post-consumer recycled content, 35% total recycled content.
- Meets or exceeds ANSI/BIFMA standards.



Light Gray (LG)

Description	ID	Black	ID	Light Gray	ID	Putty	W x D x H	Shpg. Wt.	Unit	Price
42" WIDE FILES										
4 Drawers	1	ALE-LF4254BL	7	ALE-LF4254LG	13	ALE-LF4254PY	42" x 19 $\frac{1}{4}$ " x 53 $\frac{1}{4}$ "	190 lbs.	Each	1,209.00
2 Drawers	2	ALE-LF4229BL	8	ALE-LF4229LG	14	ALE-LF4229PY	42" x 19 $\frac{1}{4}$ " x 28 $\frac{3}{4}$ "	150 lbs.	Each	759.00
36" WIDE FILES										
4 Drawers	3	ALE-LF3654BL	9	ALE-LF3654LG	15	ALE-LF3654PY	36" x 19 $\frac{1}{4}$ " x 53 $\frac{1}{4}$ "	189 lbs.	Each	1,149.00
2 Drawers	4	ALE-LF3629BL	10	ALE-LF3629LG	16	ALE-LF3629PY	36" x 19 $\frac{1}{4}$ " x 28 $\frac{3}{4}$ "	140 lbs.	Each	699.00
30" WIDE FILES										
4 Drawers	5	ALE-LF3054BL	11	ALE-LF3054LG	17	ALE-LF3054PY	30" x 19 $\frac{1}{4}$ " x 53 $\frac{1}{4}$ "	168 lbs.	Each	999.00
2 Drawers	6	ALE-LF3029BL	12	ALE-LF3029LG	18	ALE-LF3029PY	30" x 19 $\frac{1}{4}$ " x 28 $\frac{3}{4}$ "	131 lbs.	Each	609.00

Additional Items

A KEY-ALIKE LOCK CORE SET—Replaces the lock core, allowing all files to be keyed alike. Order one lock-core kit per Metal Lateral File or Steel Desk item.

ID No.	Qty.	Unit	Price
19 ALE-KCSDLF	1	Kit	45.00

B TWO ROW HANGRAILS—Creates two rows of front-to-back letter/legal size filing in one drawer of a 30" or 36" wide drawer.

ID No.	Qty.	Unit	Price
20 ALE-LF3036	4	Pack	55.00

C THREE ROW HANGRAILS—Creates three rows of front-to-back letter size filing in 42" files. Two rails per pack; order one pack per drawer/shelf.

ID No.	Qty.	Unit	Price
21 ALE-LF42	2	Pack	70.00

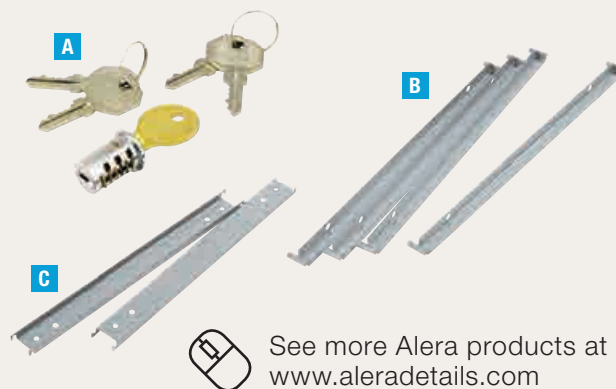

See more Alera products at www.aleradetails.com

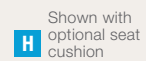

Metal Pedestal Files

Box drawers include one divider and pencil tray.

- High-sided file drawers include legal conversion bar.
- Counterweight prevents tipping.
- Core-changeable lock.
- Steel ball bearing slide suspension with $\frac{3}{4}$ extension on box drawers and full-length extension on file drawers.
- Manufacturer's limited five-year warranty.
- Meets or exceeds ANSI/BIFMA Standards.



Description	ID Black	ID Charcoal	ID Light Gray	ID Putty	W x D x H	Shpg. Wt.	Unit	Price	
A - C MOBILE FILE PEDESTAL WITH FULL LENGTH PULL —High-sided file drawer accommodates letter/legal filing. Counterweight prevents tipping. Wheels allow easy mobility and lock for security.									
A BOX/BOX/FILE —Two 6" high box drawers, one 12" high file drawer. Includes both casters or glides for stationary use.									
19½" Deep	4 ALE-PBBBFBL	10 ALE-PBBBFCH	16 ALE-PBBBFLG	22 ALE-PBBBFPY	14 $\frac{7}{8}$ " x 19 $\frac{1}{8}$ " x 27 $\frac{3}{4}$ "	77 lbs.	Each	419.00	
B BOX/FILE —One 6" high box drawer and one 12" high file drawer.									
19½" Deep	5 ALE-PBBFBL	11 ALE-PBBFCH	17 ALE-PBBFLG	23 ALE-PBBFPY	14 $\frac{7}{8}$ " x 19 $\frac{1}{8}$ " x 21 $\frac{1}{2}$ "	55 lbs.	Each	349.00	
C FILE/FILE —Two 12" high file drawers. Includes both casters or glides for stationary use.									
19½" Deep	6 ALE-PBFFBL	12 ALE-PBFFCH	18 ALE-PBFFLG	24 ALE-PBFFPY	14 $\frac{7}{8}$ " x 19 $\frac{1}{8}$ " x 27 $\frac{3}{4}$ "	70 lbs.	Each	399.00	
D - F MOBILE FILE PEDESTAL WITH RECESSED PULLS —Recessed drawer pull. Four casters (two locking) for mobility. File drawer accommodates letter/legal filing. Counterweight prevents tipping.									
D BOX/BOX/FILE —Two 6" high box drawers, one 12" high file drawer. Includes both casters or glides for stationary use.									
19½" Deep	7 ALE-PABBFBL	13 ALE-PABBFCH	19 ALE-PABBFLG	25 ALE-PABBFPY	14 $\frac{7}{8}$ " x 19 $\frac{1}{8}$ " x 27 $\frac{3}{4}$ "	75 lbs.	Each	369.00	
E BOX/FILE —One 6" high box drawer and one 12" high file drawer.									
19½" Deep	8 ALE-PABFBL	14 ALE-PABFCH	20 ALE-PABFLG	26 ALE-PABFPY	14 $\frac{7}{8}$ " x 19 $\frac{1}{8}$ " x 21 $\frac{1}{2}$ "	55 lbs.	Each	319.00	
F FILE/FILE —Two 12" high file drawers. Includes both casters or glides for stationary use.									
19½" Deep	9 ALE-PAFFBL	15 ALE-PAFFCH	21 ALE-PAFFLG	27 ALE-PAFFPY	14 $\frac{7}{8}$ " x 19 $\frac{1}{8}$ " x 27 $\frac{3}{4}$ "	73 lbs.	Each	349.00	
ID ACCESSORIES FOR ALERA PEDESTAL FILES									
G LOCK CORE FOR METAL PEDESTALS —Easy to install lock for use to key-alike all Alera® Metal Pedestals. Set includes lock core, core removal key and four keys.									
1 ALE-KC501111								Set	20.00

Seat Cushion

- Add a cushion to the top of any Alera® Pedestal or Low Credenza for instant seating.
- Soft resilient foam covered in soft long-lasting fabric.
- Rubber grip bottom surface holds cushion in place without slipping; but easily repositionable.
- Two inch thick cushions offer just the right amount of support.
- Contains 10% post-consumer recycled content, 60% total recycled content. ♻️ ♻️



ID No.	W x D x H	Color	Unit	Price
H PEDESTAL FILE SEAT CUSHION				
2	14 $\frac{7}{8}$ " x 19 $\frac{1}{8}$ " x 2 $\frac{1}{8}$ "	Smoke	Each	79.00
3	14 $\frac{7}{8}$ " x 19 $\frac{1}{8}$ " x 2 $\frac{1}{8}$ "	Tan Quartz	Each	79.00

17-AL-L-A3L



Valencia™ Series

- Commercial-grade 1" thick laminate worksurface and side panels are water-, scratch- and dent-resistant, featuring protective edge banding.
- Full extension ball-bearing slides on file drawers for easy access.
- Five casters, two locking; center caster prevents tipping.
- Locking drawers with fold-away safety keys.
- Manufacturer's limited five-year warranty.
- Meets or exceeds ANSI/BIFMA Standards.



A



Mahogany (MY)

B



Modern Walnut (WA)

new



ID No.	Color	W × D × H	Shpg. Wt.	Unit	Price
A MOBILE PEDESTAL FILE					
1	ALE-VA572816ES Espresso	15 $\frac{1}{2}$ " × 20 $\frac{1}{2}$ " × 28 $\frac{3}{4}$ "	77 lbs.	Each	370.00
2	ALE-VA572816MY Mahogany	15 $\frac{1}{2}$ " × 20 $\frac{1}{2}$ " × 28 $\frac{3}{4}$ "	77 lbs.	Each	370.00
3	ALE-VA572816MC Medium Cherry	15 $\frac{1}{2}$ " × 20 $\frac{1}{2}$ " × 28 $\frac{3}{4}$ "	77 lbs.	Each	370.00

ID No.	Color	W × D × H	Shpg. Wt.	Unit	Price
B MOBILE BOX/FILE PEDESTAL					
6	ALE-VABFES Espresso	14 $\frac{3}{4}$ " × 19 $\frac{1}{2}$ " × 22 $\frac{7}{8}$ "	55 lbs.	Each	299.00
7	ALE-VABFMY Mahogany	14 $\frac{3}{4}$ " × 19 $\frac{1}{2}$ " × 22 $\frac{7}{8}$ "	55 lbs.	Each	299.00
8	ALE-VABFMC Medium Cherry	14 $\frac{3}{4}$ " × 19 $\frac{1}{2}$ " × 22 $\frac{7}{8}$ "	55 lbs.	Each	299.00
9	ALE-VABFWA Modern Walnut	14 $\frac{3}{4}$ " × 19 $\frac{1}{2}$ " × 22 $\frac{7}{8}$ "	55 lbs.	Each	299.00

Seat Cushion

- Add a cushion to the top of any Alera® Pedestal or Low Credenza for instant seating.
- Soft resilient foam covered in soft long-lasting fabric.
- Rubber grip bottom surface holds cushion in place without slipping; but easily repositionable.
- Two inch thick cushions offer just the right amount of support.
- Contains 10% post-consumer recycled content, 60% total recycled content. ♻️ ♻️

ID No.	W × D × H	Color	Unit	Price
C PEDESTAL FILE SEAT CUSHION				
4	ALE-PC1511 14 $\frac{7}{8}$ " × 19 $\frac{1}{2}$ " × 2 $\frac{1}{4}$ "	Smoke	Each	79.00
5	ALE-PC1551 14 $\frac{7}{8}$ " × 19 $\frac{1}{2}$ " × 2 $\frac{1}{4}$ "	Tan Quartz	Each	79.00



C

new



A



B



C



D



ROLLING FILE CART

Accommodates letter and legal size hanging files. Versatile front to back or side to side filing. Can be assembled with no tools in about 60 seconds. Lower shelf supports up to 150 lbs. Meets or exceeds ANSI/BIFMA Standards.

ID No.	Color	W x D x H	Shpg. Wt.	Unit	Price
A SINGLE-TIER FILE UNIT —Side-to-side filing only.					
1	ALE-FW60-1424BL	Black	24" x 14" x 21"	12 lbs.	Each 80.00
B TWO-TIER FILE UNIT —Front-to-back and side-to-side filing.					
2	ALE-FW60-1426BL	Black	26" x 14" x 29½"	17 lbs.	Each 110.00

C WIRE SHELVING THREE-TIER ROLLING CART

Sturdy and solid wire cart for mobile shelving needs. Includes four casters (two locking). Black Anthracite finish for wet and dry usages. Shelves adjust in 1" increments. 500 lbs. total weight capacity. Manufacturer's limited five-year warranty. Meets or exceeds ANSI/BIFMA Standards.

ID No.	Finish	W x D x H	Shpg. Wt.	Unit	Price
Four 4" Casters —Two wire shelves, one wire basket, three shelf liners, four 35" poles and one pull handle.					
3	ALE-SW543018BA	Black Anthracite	34" x 18" x 40"	41 lbs.	Each 240.00
Four 3" Casters —Two wire shelves, one wire basket, four poles and one pull handle.					
4	ALE-SW342416BA	Black Anthracite	28" x 16" x 39"	26 lbs.	Each 150.00

D CARRY-ALL CART/MAIL CART

7" deep top basket can accommodate letter- or legal-size files with included adjustable file rods. Sturdy bottom basket with 4" raised sides. Heavy-duty metal tube and wire construction resists scratches and withstands constant use. Snaps together in minutes without tools. Shelf and basket height adjustable in 1" increments. Manufacturer's limited five-year warranty.

ID No.	Finish	W x D x H	Shpg. Wt.	Unit	Price
5	ALE-MC3518SR	Silver	34¾" x 18" x 39½"	29 lbs.	Each 315.00



Fast Delivery
In most cases, the next business day!

Storage

Find a place for everything to create order out of chaos.



Smart storage makes the difference between a well-ordered, productive workspace and wasted space and time. Clear away the clutter and you'll clear the way to get more done. Our wide range of storage solutions lets you organize everything from office supplies to food to personal items to tools so you can spend less time searching and more time on what matters.

Shelving	69-72
Cabinets	73
Bookcases	74, 75
Breakroom	76, 77

Quick Comparison Chart

For Alera Wire Shelving

Consider what you'll be storing, how often you need to access the stored items and where the shelving will be placed.



Type	Heavy Duty Industrial	Medium Duty Commercial	Light Duty Residential
Weight Capacity per Shelf	Up to 1200 lbs.	Up to 600 lbs.	Up to 300 lbs.
Access Frequency	High	Medium	Low
Finish Durability	NSF Wet/Dry Environment or Dry Environment	NSF Dry Environment	NSF Dry Environment
Shelf Width(s)	36", 48" and 60"	48"	36"
Shelf Depth(s)	18" and 24"	18"	14"
Half-Height Kit Included	Yes	No	No
Warranty/Corrosion	5-year/8-year limited	5-year limited	5-year limited



Heavy-Duty Industrial Wire Shelving

Find your ideal storage solution for industrial, foodservice, medical industry and all other storage needs.

- NSF certified for wet/dry or dry only environments.
- Reinforced extra-strong welded wire construction provides unmatched strength and stability.
- Open design that allows for air circulation.
- Shelves adjust in 1" increments.
- Can be set up as a four-tier single rack or as two two-tier racks to meet specific needs.
- Meets or exceeds ANSI/BIFMA Standards.



See more Alera products at www.aleradetails.com

A BA PLUS WIRE SHELVING KIT

Universal storage solution ideal for industrial, food service and medical and all other storage needs. Long-lasting industrial-grade finish resists corrosion in even the harshest environment, wet or dry. Heavy-duty shelves withstand constant re-stocking. Can be used in freezer applications and with an open design that allows for air circulation. Snap-together design assembles in minutes without tools. Can be set up as a four-tier single rack or as two two-tier racks to meet specific needs. Shelves adjust in 1" increments. Manufacturer's five year limited warranty, eight year corrosion warranty.

ID No.	Finish	W x D x H	Shpg. Wt.	Unit	Price
24" Deep 4 Shelf Kit —Up to 1,000 lbs. per shelf (evenly distributed).					
1	ALE-SW206024BA *	Black Anthracite Plus	60" x 24" x 72"	103 lbs.	Each 520.00
2	ALE-SW204824BA *	Black Anthracite Plus	48" x 24" x 72"	80 lbs.	Each 440.00
18" Deep 4 Shelf Kit —Up to 1,000 lbs. per shelf (evenly distributed).					
3	ALE-SW206018BA *	Black Anthracite Plus	60" x 18" x 72"	86 lbs.	Each 470.00
4	ALE-SW204818BA *	Black Anthracite Plus	48" x 18" x 72"	68 lbs.	Each 430.00

* Use of casters (optional) may reduce total weight capacity.

B BLACK ANTHRACITE WIRE SHELVING KIT

Ideal storage solution for commercial and restaurant use. Black Anthracite finish is National Sanitation Foundation (NSF) certified for wet and dry environments. Includes four shelves, eight 36" posts, floor leveling glides and conversion kit to convert to two half-height two-shelf units. Shelves adjust in 1" increments. Meets or exceeds ANSI/BIFMA Standards. Manufacturer's limited five year warranty.

ID No.	Finish	W x D x H	Shpg. Wt.	Unit	Price
24" Deep 4 Shelf Kit —Up to 1,000 lbs. per shelf (evenly distributed).					
5	ALE-SW50-4824BA *	Black Anthracite	48" x 24" x 72"	80 lbs.	Each 420.00
6	ALE-SW50-3624BA *	Black Anthracite	36" x 24" x 72"	65 lbs.	Each 370.00
18" Deep 4 Shelf Kit —Up to 1,250 lbs. per shelf (evenly distributed).					
7	ALE-SW50-4818BA *	Black Anthracite	48" x 18" x 72"	72 lbs.	Each 400.00
8	ALE-SW50-3618BA *	Black Anthracite	36" x 18" x 72"	60 lbs.	Each 330.00

* Use of casters (optional) may reduce total weight capacity.

Prices subject to change without notice.
Visit our website for the latest pricing and product information.



Black



Black Anthracite



Silver

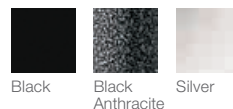

Heavy-Duty Industrial Wire Shelving

Find your ideal storage solution for industrial, foodservice, medical industry and all other storage needs.

- NSF certified for wet/dry or dry only environments.
- Reinforced extra-strong welded wire construction provides unmatched strength and stability.
- Open design that allows for air circulation.
- Shelves adjust in 1" increments.
- Can be set up as a four-tier single rack or as two two-tier racks to meet specific needs.
- Manufacturer's limited five-year warranty.
- Meets or exceeds ANSI/BIFMA Standards.

A INDUSTRIAL HEAVY-DUTY WIRE SHELVING STARTER KIT

Strong welded wire construction storage units. Includes four shelves, eight 36" posts, shelf clips, feet leveling glides and conversion kit to create two half height (36"h) two-shelf storage units. Shelves adjust in 1" increments.

ID No.	Finish	W x D x H	Shpg. Wt.	Unit	Price
4-Shelf Kit —Up to 1,000 lbs. per shelf (evenly distributed).					
1	ALE-SW50-4824BL	Black	48" x 24" x 72"	80 lbs.	Each 400.00
2	ALE-SW50-4824SR	Silver	48" x 24" x 72"	80 lbs.	Each 400.00
3	ALE-SW50-3624BL	Black	36" x 24" x 72"	65 lbs.	Each 350.00
4	ALE-SW50-3624SR	Silver	36" x 24" x 72"	65 lbs.	Each 350.00
4-Shelf Kit —Up to 1,250 lbs. per shelf (evenly distributed).					
5	ALE-SW50-4818BL	Black	48" x 18" x 72"	72 lbs.	Each 370.00
6	ALE-SW50-4818SR	Silver	48" x 18" x 72"	72 lbs.	Each 370.00
7	ALE-SW50-3618BL	Black	36" x 18" x 72"	60 lbs.	Each 320.00
8	ALE-SW50-3618SR	Silver	36" x 18" x 72"	60 lbs.	Each 320.00

* Use of casters (optional) may reduce total weight capacity.

Medium-Duty Commercial Wire Shelving

The perfect solution for all your storage needs.

- NSF certified for wet/dry or dry only environments.
- Snap-together design assembles in minutes.
- Strong welded wire construction provides exceptional strength and stability.
- Open design allows air circulation and reduces dust build-up.
- Manufacturer's limited five-year warranty.
- Meets or exceeds ANSI/BIFMA Standards.

B COMMERCIAL MEDIUM-DUTY WIRE SHELVING UNIT WITH CASTERS

Sturdy and solid shelving for business or restaurant environments. Includes four shelves, posts, shelf clips, leveling glides and four 3" casters (two locking).

ID No.	Finish	W x D x H	Shpg. Wt.	Unit	Price
4-Shelf Kit —Up to 600 lbs. per shelf (evenly distributed) when used without casters.					
9	ALE-SW604818BL	Black	48" x 18" x 72"	55 lbs.	Each 275.00
10	ALE-SW604818BA	Black Anthracite	48" x 18" x 72"	55 lbs.	Each 280.00
11	ALE-SW604818SR	Silver	48" x 18" x 72"	55 lbs.	Each 280.00

* Shelf weight capacity and overall unit weight capacity as shown, if used without casters. If using casters the overall unit weight capacity drops to 500 lbs.

C COMMERCIAL MEDIUM-DUTY WIRE SHELVING KIT

Ideal storage solution for commercial use. Includes six shelves, posts, shelf clips and leveling glides. Up to 600 lbs. per shelf (evenly distributed).

ID No.	Finish	W x D x H	Shpg. Wt.	Unit	Price
6-Shelf Kit —Up to 600 lbs. per shelf (evenly distributed).					
12	ALE-SW664818BL	Black	48" x 18" x 72"	70 lbs.	Each 290.00
13	ALE-SW664818BA	Black Anthracite	48" x 18" x 72"	70 lbs.	Each 300.00
14	ALE-SW664818SR	Silver	48" x 18" x 72"	70 lbs.	Each 290.00

* Use of casters (optional) may reduce total weight capacity.



Wire Shelves and Accessories

Add extra shelves to existing units, build your own customized unit, or add on shelf extensions and convenient storage accessories with these shelves.

- Strong welded wire construction provides exceptional strength and stability.
- Open design allows air circulation and helps reduce dust build-up.
- Snap-together design assembles in minutes.
- Manufacturer's limited five-year warranty.
- Meets or exceeds ANSI/BIFMA Standards.

A HEAVY-DUTY WIRE SHELVEING EXTRA WIRE SHELVES

ID No.	Finish	W x D	Shpg. Wt.	Unit	Price
24" Deep —Up to 1,000 lbs. per shelf (evenly distributed).					
1	ALE-SW58-4824BL	Black 48" x 24"	35 lbs.	Carton	180-00
2	ALE-SW58-3624BL	Black 36" x 24"	28 lbs.	Carton	150-00
3	ALE-SW58-4824SR	Silver 48" x 24"	35 lbs.	Carton	180-00
4	ALE-SW58-3624SR	Silver 36" x 24"	28 lbs.	Carton	150-00
24" Deep —Up to 600 lbs. per shelf (evenly distributed).					
5	ALE-SW58-2424BL	Black 24" x 24"	15 lbs.	Carton	90-00
6	ALE-SW58-2424SR	Silver 24" x 24"	15 lbs.	Carton	90-00
18" Deep —Up to 1,250 lbs. per shelf (evenly distributed).					
7	ALE-SW58-4818BL	Black 48" x 18"	31 lbs.	Carton	160-00
8	ALE-SW58-3618BL	Black 36" x 18"	24 lbs.	Carton	130-00
9	ALE-SW58-4818SR	Silver 48" x 18"	31 lbs.	Carton	160-00
10	ALE-SW58-3618SR	Silver 36" x 18"	24 lbs.	Carton	130-00
18" Deep —Up to 600 lbs. per shelf (evenly distributed).					
11	ALE-SW58-2418BL	Black 24" x 18"	12 lbs.	Carton	80-00
12	ALE-SW58-1818BL	Black 18" x 18"	10 lbs.	Carton	70-00
13	ALE-SW58-2418SR	Silver 24" x 18"	12 lbs.	Carton	80-00
14	ALE-SW58-1818SR	Silver 18" x 18"	10 lbs.	Carton	70-00

B STACKABLE POSTS

Add-on poles allows you to easily add on shelves or create custom sized units (combined with Extra Shelves and Shelf Connecting Hooks). Includes levers for uneven floors and four 36" posts, combine two posts for 72" shelving. Manufacturer's limited five-year warranty.

ID No.	Finish	Height	Qty.	Unit	Price
Stackable Posts —Allows you to easily add on shelves or half-height shelf units. Levers for uneven floor. Combine two posts for 72" high shelving.					
15	ALE-SW59-P036BL	Black 36"	4	Pack	60-00
16	ALE-SW59-P036SR	Silver 36"	4	Pack	60-00

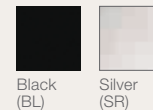

C - K ALSO CONSIDER:

ID	No.	Description	Qty.	Unit	Price
17	C	ALE-SW59ST Shelf Tags, Gray, 3" Wide	10	Pack	10-00
18	D	ALE-SW59SHBL Shelf Connecting S Hooks, Black	4	Pack	10-00
19		ALE-SW59SHSR Shelf Connecting S Hooks, Silver	4	Pack	10-00
20	E	ALE-SW59SLBL Shelf Lock Clips, Black	4	Pack	6-50
21	F	ALE-SW248SV Wire Mesh Nesting Shelving Baskets, Silver	2	Pack	45-00
22	G	ALE-SW258SV Wire Mesh Stacking Shelving Bins, Silver	2	Pack	49-00
23	H	ALE-SW59SL4824 Shelf Liner, 48 x 24, Clear	4	Pack	115-00
24		ALE-SW59SL4818 Shelf Liner, 48 x 18, Clear	4	Pack	95-00
25		ALE-SW59SL3624 Shelf Liner, 36 x 24, Clear	4	Pack	95-00
26		ALE-SW59SL3618 Shelf Liner, 36 x 18, Clear	4	Pack	65-00
27	I	ALE-SW59HB418SR Four Hook Bar, 18" Deep, Silver	2	Pack	30-00
28		ALE-SW59HB424SR Five Hook Bar, 24" Deep, Silver	2	Pack	40-00
29	J	ALE-SW59BS48SR Wall Saver Support, 48" Wide, Silver	2	Pack	40-00
30		ALE-SW59BS36SR Wall Saver Support, 36" Wide, Silver	2	Pack	30-00
31		ALE-SW790004 3" Casters, 2 Locking	4	Set	80-00
32	K	ALE-SW59-0004 5" Casters with Bumpers, 2 Locking	4	Set	110-00

* Using casters may reduce load capacity for the shelving unit.

Customize and reconfigure your shelving for ideal storage with add-on components.



Shelf Tags
Snaps on; includes paper labels.



Shelf Connecting Hooks
Use to secure additional shelves together.



Shelf Lock Clips



Wire Mesh Nesting Shelving Basket Can be nested for easy put-away.



Wire Mesh Stacking Shelving Bins Fold over handles for secure stacking.



Shelf Liners
Prevents small items from falling through.



Hook Bars

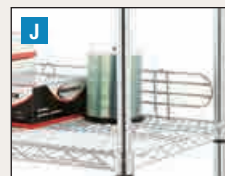

Wall Saver Back Supports
Prevents items from falling off.



Casters
Add optional casters to create a fully mobile solution

Storage Shelving

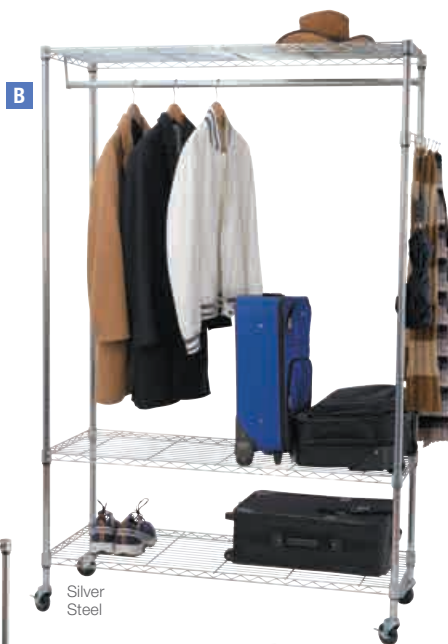

Residential Light-Duty Wire Shelving Kit

A RESIDENTIAL WIRE SHELVING

An economical storage solution for light duty applications. Snap-together design assembles in minutes. Strong welded wire construction provides exceptional strength and stability. Open design allows air circulation and reduces dust build-up. Up to 250 lbs. per shelf (evenly distributed). Meets or exceeds ANSI/BIFMA Standards. Manufacturer's limited five-year warranty.

ID No.	Finish	W x D x H	Shpg. Wt.	Unit	Price
5-Shelf Kit					
1	ALE-SW853614SR	Silver	36" x 14" x 72"	33 lbs.	Each 179.00
4-Shelf Kit					
2	ALE-SW843614SR	Silver	36" x 14" x 54"	29 lbs.	Each 150.00
3-Shelf Kit					
3	ALE-SW833614SR	Silver	36" x 14" x 36"	22 lbs.	Each 130.00

Use of casters (optional) may reduce total weight capacity.

B WIRE SHELVING GARMENT RACK

Includes three shelves, posts, shelf clips, hook bar, and casters (2 locking).

ID No.	Finish	W x D x H	Unit	Price
4	ALE-GR364818BL	Black	48" x 18" x 75"	Each 315.00
5	ALE-GR364818SR	Silver	48" x 18" x 75"	Each 315.00

C WIRE GARMENT TOWER

Includes three shelves, posts, shelf clips, hook bar, and casters (2 locking).

ID No.	Finish	W x D x H	Unit	Price
6	ALE-GR351818BL	Black	18" x 18" x 81 $\frac{3}{4}$ "	Each 160.00
7	ALE-GR351818SR	Silver	18" x 18" x 81 $\frac{3}{4}$ "	Each 160.00

D WIRE SHELF RACK

Sturdy welded steel wall mounted wire shelf with garment rod provides exceptional strength and stability. Includes shelf, shelf brackets, garment rod and mounting template for easy and level wall placement. Hangers not included.

ID No.	Finish	W x D x H	Unit	Price
8	ALE-WS3618SR	Silver	36" x 18" x 7 $\frac{1}{2}$ "	Each 140.00
9	ALE-WS4818SR	Silver	48" x 18" x 7 $\frac{1}{2}$ "	Each 150.00

E WIRE SHELVING THREE-TIER ROLLING CART

Sturdy and solid wire cart for mobile shelving needs. Includes four casters (two locking). Black Anthracite finish for wet and dry usages. Shelves adjust in 1" increments. 500 lbs. total weight capacity. Manufacturer's limited five-year warranty. Meets or exceeds ANSI/BIFMA Standards.

ID No.	Finish	W x D x H	Shpg. Wt.	Unit	Price
Four 4" Casters —Two wire shelves, one wire basket, three shelf liners, four 35" poles and one pull handle.					
10	ALE-SW543018BA	Black Anthracite	34" x 18" x 40"	41 lbs.	Each 240.00
Four 3" Casters —Two wire shelves, one wire basket, four poles and one pull handle.					
11	ALE-SW342416BA	Black Anthracite	28" x 16" x 39"	26 lbs.	Each 150.00

F CARRY-ALL CART/MAIL CART

7" deep top basket can accommodate letter- or legal-size files with included adjustable file rods. Sturdy bottom basket with 4" raised sides. Heavy-duty steel tubing resists scratches and withstands constant use. Snaps together in minutes without tools. Shelf and basket height adjustable in 1" increments. Manufacturer's limited five-year warranty.

ID No.	Finish	W x D x H	Shpg. Wt.	Unit	Price
12	ALE-MC3518SR	Silver	34 $\frac{7}{8}$ " x 18" x 39 $\frac{1}{2}$ "	29 lbs.	Each 315.00



Storage Cabinets

A - B HEAVY DUTY WELDED STORAGE CABINET

Shelves adjust in 2" increments. Reinforced doors with satin chrome double handles open 180°. Secure three-point locking rod system locks top, bottom and doors. Industrial-grade steel with powder coat finish. Sturdy 16 gauge door frame prevents racking. Heavy duty secure knuckle hinges for longevity. Leveling glides compensate for uneven floors. Manufacturer's limited five-year warranty. SCS Indoor Advantage Gold Certified; Meets or exceeds ANSI/BIFMA Standards.

ID No.	Color	W x D x H	Shpg. Wt.	Unit	Price
A 78" HIGH CABINET —Four adjustable shelves.					
1	ALE-CM7824BK	Black	36" x 24" x 78"	178 lbs.	Each 859.00
2	ALE-CM7824LG	Light Gray	36" x 24" x 78"	178 lbs.	Each 859.00
3	ALE-CM7824PY	Putty	36" x 24" x 78"	178 lbs.	Each 859.00
4	ALE-CM7818BK	Black	36" x 18" x 78"	154 lbs.	Each 769.00
5	ALE-CM7818LG	Light Gray	36" x 18" x 78"	154 lbs.	Each 769.00
6	ALE-CM7818PY	Putty	36" x 18" x 78"	154 lbs.	Each 769.00
72" HIGH CABINET —Four adjustable shelves.					
7	ALE-CM7218BK	Black	36" x 18" x 72"	145 lbs.	Each 759.00
8	ALE-CM7218LG	Light Gray	36" x 18" x 72"	145 lbs.	Each 759.00
9	ALE-CM7218PY	Putty	36" x 18" x 72"	145 lbs.	Each 759.00
B 42" HIGH CABINET —Two adjustable shelves.					
10	ALE-CM4218BK	Black	36" x 18" x 42"	92 lbs.	Each 575.00
11	ALE-CM4218LG	Light Gray	36" x 18" x 42"	92 lbs.	Each 575.00
12	ALE-CM4218PY	Putty	36" x 18" x 42"	92 lbs.	Each 575.00

C SPACE SAVER ASSEMBLED STORAGE CABINET

Industrial grade steel cabinet with powder coat putty finish works best where space is at a premium. Secure three-point locking system locks top, bottom and doors. Narrower depth allows use in tight areas; shorter height is ideal for use next to panel systems. Four adjustable shelves. Recessed locking handle. Manufacturer's limited five-year warranty. SCS Indoor Advantage Gold Certified; Meets or exceeds ANSI/BIFMA Standards.

ID No.	Color	W x D x H	Shpg. Wt.	Unit	Price
13	ALE-CM6615PY	Putty	30" x 15" x 66"	77 lbs.	Each 705.00



D - E ECONOMY ASSEMBLED STORAGE CABINET

Industrial grade steel with powder coat finish and polished chrome handle. Secure three point locking system locks top, bottom and doors. Adjustable shelves adjust in 2" increments. Reinforced doors open 180°. Manufacturer's limited five-year warranty. SCS Indoor Advantage Gold Certified; Meets or exceeds ANSI/BIFMA Standards.

ID No.	Color	W x D x H	Shpg. Wt.	Unit	Price
D 72" HIGH CABINET —One fixed and three adjustable shelves.					
14	ALE-CME7218PY	Putty	36" x 18" x 72"	123 lbs.	Each 629.00
E 42" HIGH CABINET —Two fixed shelves.					
15	ALE-CME4218PY	Putty	36" x 18" x 42"	76 lbs.	Each 459.00

F MOBILE STORAGE CABINET

Fully enclosed, fully assembled industrial grade welded steel cabinets hold up to 900 lbs. Secure three-point locking bar system locks top, bottom and doors. Reinforced doors with recessed handles open 180°. Heavy-duty caster base has four 5" casters, two locking. Manufacturer's limited five-year warranty. SCS Indoor Advantage Gold Certified; Meets or exceeds ANSI/BIFMA Standards.

ID No.	Color	W x D x H	Shpg. Wt.	Unit	Price
Three Adjustable Shelves					
16	ALE-CM6624PY	Putty	36" x 24" x 66"	162 lbs.	Each 959.00

Prices subject to change without notice.
Visit our website for the latest pricing and product information.

Storage Bookcases



See more Alera products at www.aleradetails.com

Veneer Bookcases

Rich wood veneer bookcases with fully-finished backs.

- Sturdy 1" thick shelves support up to 95 lbs each.
- 11¾" deep shelves store large publications.
- UV veneer finish provides scratch and spill resistance.
- Shelves adjust in 1¼" increments.
- Shelf count includes bottom of bookcase.
- Wood veneer bookcases with square corners.
- Manufacturer's limited five-year warranty.
- Meets or exceeds ANSI/BIFMA Standards.



Mahogany (MY)



Medium Cherry (MC)

Description	ID Mahogany	ID Medium Cherry	W x D x H	Shpg. Wt.	Unit	Price
A VENEER SQUARE CORNER BOOKCASE						
7 Shelves	1 ALE-BCS78436MY	8 ALE-BCS78436MC	35½" x 11¾" x 84"	151 lbs.	Each	725.00
6 Shelves	2 ALE-BCS67236MY	9 ALE-BCS67236MC	35½" x 11¾" x 72"	128 lbs.	Each	605.00
5 Shelves	3 ALE-BCS56036MY	10 ALE-BCS56036MC	35½" x 11¾" x 60"	116 lbs.	Each	525.00
4 Shelves	4 ALE-BCS44836MY	11 ALE-BCS44836MC	35½" x 11¾" x 48"	90 lbs.	Each	450.00
3 Shelves	5 ALE-BCS33636MY	12 ALE-BCS33636MC	35½" x 11¾" x 36"	68 lbs.	Each	330.00
2 Shelves	6 ALE-BCS23036MY	13 ALE-BCS23036MC	35½" x 11¾" x 30"	51 lbs.	Each	200.00
B NARROW PROFILE BOOKCASE WITH FINISHED BACK						
6 Shelves	7 ALE-BCS67212MY	14 ALE-BCS67212MC	12" x 11¾" x 72"	65 lbs.	Each	315.00



Laminate Bookcases

Contemporary design; woodgrain laminate construction.

- Commercial-grade panels are water-, scratch- and dent-resistant, with protective 3 mm edge banding.
- 11¾" deep adjustable shelves.
- Top panel is 14" deep for door installation.
- Tight, dowel and cam-lock assembly.
- Matching components with Valencia Office Suites.
- Manufacturer's limited five-year warranty.
- Meets or exceeds ANSI/BIFMA Standards.

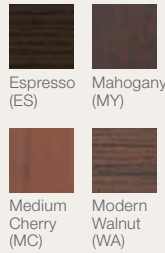

Metal leveling glides compensate for uneven floors.

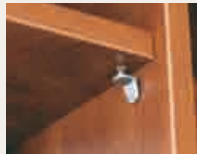

Locking shelf supports.



Commercial-grade shelves resist bowing.



Cabinet Door Kit

Description	ID	Espresso	ID	Mahogany	ID	Medium Cherry	ID	Modern Walnut	W × D × H	Shpg. Wt.	Unit	Price
6 Shelves	1	ALE-VA638232ES	7	ALE-VA63-8232MY	13	ALE-VA63-8232MC	19	ALE-VA638232WA	31¾" × 14" × 80¾"	154 lbs.		Each 420.00
5 Shelves	2	ALE-VA636632ES	8	ALE-VA63-6632MY	14	ALE-VA63-6632MC	20	ALE-VA636632WA	31¾" × 14" × 65"	129 lbs.		Each 330.00
4 Shelves	3	ALE-VA635632ES	9	ALE-VA63-5632MY	15	ALE-VA63-5632MC	21	ALE-VA635632WA	31¾" × 14" × 55"	109 lbs.		Each 280.00
3 Shelves	4	ALE-VA634432ES	10	ALE-VA63-4432MY	16	ALE-VA63-4432MC	22	ALE-VA634432WA	31¾" × 14" × 39¾"	77 lbs.		Each 230.00
2 Shelves	5	ALE-VA633032ES	11	ALE-VA63-3032MY	17	ALE-VA63-3032MC	23	ALE-VA633032WA	31¾" × 14" × 29½"	67 lbs.		Each 210.00

ADDITIONAL ITEMS

Description	ID	Espresso	ID	Mahogany	ID	Medium Cherry	ID	Modern Walnut	W × D × H	Shpg. Wt.	Unit	Price
Bookcase Cabinet Door Kit	6	ALE-VA632832ES	12	ALE-VA63-2832MY	18	ALE-VA63-2832MC	24	ALE-VA632832WA	31¾" × 25¼"	18 lbs.	Set	110.00

Use one kit to enclose 29½" high bookcase or lower portion of 40" high bookcase. Use two kits to fully enclose 55" high bookcase or lower and upper portion of 65" high bookcase. Use three kits to fully enclose 81" high bookcase. Lockable with two fold-over safety keys.

Prices subject to change without notice.
Visit our website for the latest pricing and product information.



Hospitality Cabinets

Ideal for office kitchens, breakrooms, cafe areas, or anywhere you need additional storage.

- Nonporous, 3/4" thick thermofused melamine laminate cabinetry is easy to clean and damage-resistant.
- Color-matched interiors and exteriors.
- Rigid structured dowel pin construction increases vertical and horizontal stability.
- Adjustable 120° concealed Euro-style hinge system with high-strength screw attachment.
- Extended length, slimline door/drawer pulls deliver style and comfort.
- Manufacturer's limited five-year warranty.
- Contains 90% pre-consumer recycled content, 5% post-consumer recycled content, 95% total recycled content. ♻️ ♻️ ♻️ ♻️ ♻️



Euro-style hinge



Door/drawer pulls



Shelf support system



Level guide



See more Alera products at www.aleradetails.com



Cherry (CY)



A

Espresso (ES)



without Hutch



with Hutch

C

Espresso (ES)



Espresso (ES)



Cherry (CY)



Gray (GY)



Espresso (ES)



Hospitality Cabinets

Ideal for office kitchens, breakrooms, cafe areas, or anywhere you need additional storage.

- Nonporous, 3/4" thick thermofused melamine laminate cabinetry is easy to clean and damage-resistant.
- Color-matched interiors and exteriors.
- Rigid structured dowel pin construction increases vertical and horizontal stability.
- Adjustable 120° concealed Euro-style hinge system with high-strength screw attachment.
- Extended length, slimline door/drawer pulls deliver style and comfort.
- Manufacturer's limited five-year warranty.
- GREENGUARD Certified
- Contains 90% pre-consumer recycled content, 5% post-consumer recycled content, 95% total recycled content. ♻️ ♻️ ♻️

A HOSPITALITY BASE CABINET

Commercial-quality cabinet is partnered with a durable Advantage laminate countertop for good looks and easy care. Adjustable levelers help compensate for uneven floors.

ID No.	Color	W × D × H	Shpg. Wt.	Unit	Price
Four Drawers/Door —Adjustable shelf with anti-tip locking tabs. Full four-sided drawer construction with removable front and laminated bottom. Heavy-duty deadbolt locking system.					
1	AAP-BR103CY	Cherry/Granite Nebula	36" × 24¾" × 40"	270 lbs.	Each 1,999.00
2	AAP-BR103ES	Espresso/White	36" × 24¾" × 40"	270 lbs.	Each 1,999.00
3	AAP-BR103GY	Gray/Granite Nebula	36" × 24¾" × 40"	270 lbs.	Each 1,999.00
Two Doors/Drawer —Adjustable shelf with anti-tip locking tabs. Full four-sided drawer construction with removable front and laminated bottom. Heavy-duty deadbolt locking system.					
4	AAP-BR102CY	Cherry/Granite Nebula	36" × 24¾" × 40"	196 lbs.	Each 1,429.00
5	AAP-BR102ES	Espresso/White	36" × 24¾" × 40"	196 lbs.	Each 1,429.00
6	AAP-BR102GY	Gray/Granite Nebula	36" × 24¾" × 40"	196 lbs.	Each 1,429.00

ID No.	Color	W × D × H	Shpg. Wt.	Unit	Price
Two Door/Six Shelf Pantry					
7	AAP-BR202CY	Cherry	14¾" × 19½" × 76¼"	193 lbs.	Each 1,399.00
8	AAP-BR202ES	Espresso	14¾" × 19½" × 76¼"	193 lbs.	Each 1,399.00
9	AAP-BR202GY	Gray	14¾" × 19½" × 76¼"	193 lbs.	Each 1,399.00
Two Doors/Two Flipper Doors —Ideal for waste management with top flipper doors and bottom trash can compartments (trash cans sold separately).					
10	AAP-BR104CY	Cherry/Granite Nebula	36" × 24¾" × 40"	180 lbs.	Each 1,779.00
11	AAP-BR104ES	Espresso/White	36" × 24¾" × 40"	180 lbs.	Each 1,779.00
12	AAP-BR104GY	Gray/Granite Nebula	36" × 24¾" × 40"	180 lbs.	Each 1,779.00
One Door/Drawer					
13	AAP-BR105CY	Cherry/Granite Nebula	40" × 28" × 44"	135 lbs.	Each 1,249.00
14	AAP-BR105ES	Espresso/White	40" × 28" × 44"	135 lbs.	Each 1,249.00
15	AAP-BR105GY	Gray/Granite Nebula	40" × 28" × 44"	135 lbs.	Each 1,249.00

B HOSPITALITY WALL CABINET

Commercial-quality cabinet has an adjustable shelf for storage flexibility. Heavy-duty deadbolt locking system provides maximum security for equipment and supplies. 🔒

ID No.	Color	W × D × H	Shpg. Wt.	Unit	Price
16	AAP-BR181CY	Cherry	36" × 14¾" × 29¾"	120 lbs.	Each 749.00
17	AAP-BR181ES	Espresso	36" × 14¾" × 29¾"	120 lbs.	Each 749.00
18	AAP-BR181GY	Gray	36" × 14¾" × 29¾"	120 lbs.	Each 749.00

C HOSPITALITY HUTCH

Commercial-quality cabinet has an adjustable shelf for storage flexibility. Heavy-duty deadbolt locking system provides maximum security for equipment and supplies.

ID No.	Color	W × D × H	Shpg. Wt.	Unit	Price
19	AAP-BR191CY	Cherry	36" × 18" × 40¼"	130 lbs.	Each 899.00
20	AAP-BR191ES	Espresso	36" × 18" × 40¼"	130 lbs.	Each 899.00
21	AAP-BR191GY	Gray	36" × 18" × 40¼"	130 lbs.	Each 899.00

Prices subject to change without notice. Visit our website for the latest pricing and product information.

Tables

Transform any area into a flexible gathering space.



One of the most versatile pieces, a table can turn a corner into a flexible gathering space, an empty room into a training center, a café into a collaboration zone. Adaptable designs that roll, fold or adjust up and down take flexibility to the next level so you can rearrange, customize and store tables away. Welcome to the endless possibilities our wide selection of tables brings.

Hospitality	79
Occasional	80
Training	81
Utility/Folding	82, 83

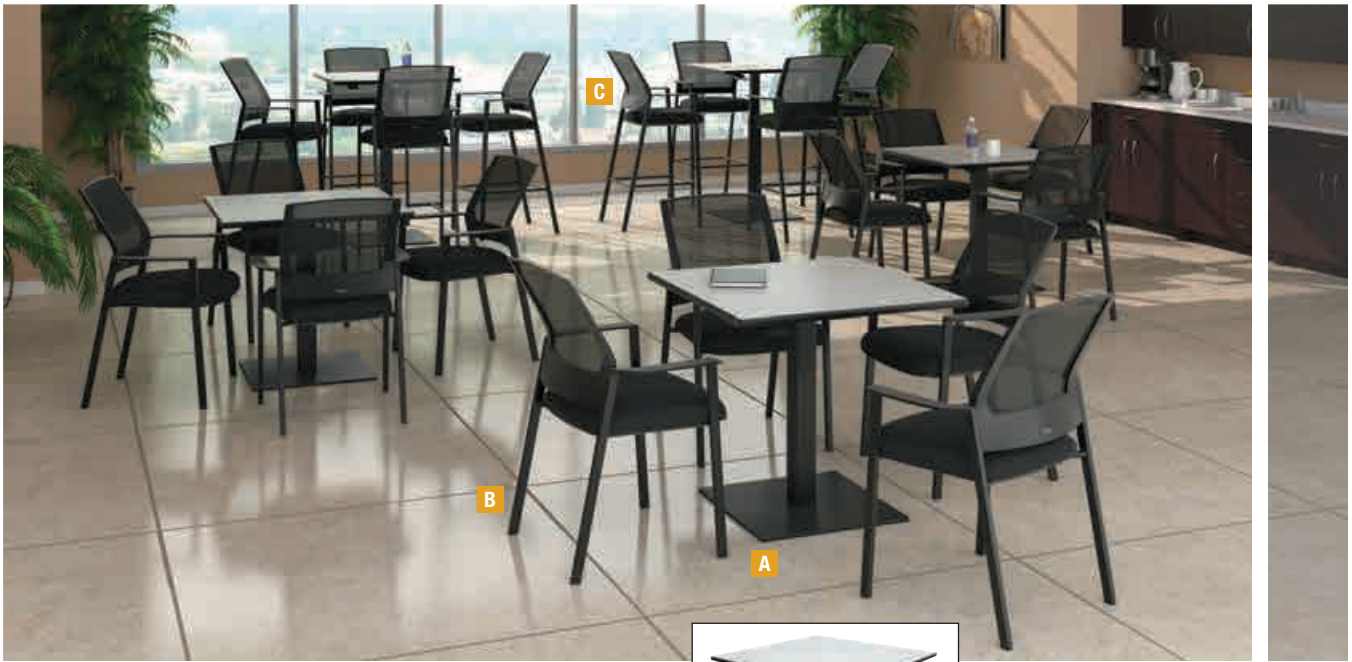

Hospitality Series Height Adjustable Table

Go from sitting to standing position in seconds with just one click.

- Adjustable-height hospitality table adjusts from 29½" to 44¼".
- Wide weighted base holds table steady and prevents accidental tipping.
- Accommodates both chairs and stools.
- Durable laminate top is water-, scratch-, and dent-resistant.
- Anti-slip feature keeps the table from accidentally rising or falling when in use.
- Versatile adjustability as a conference or bistro table.
- Laminate top.
- Manufacturer's limited five-year warranty.
- Meets or exceeds ANSI/BIFMA Standards.



ID No.	Color	W × D × H	Shpg. Wt.	Unit	Price
A HOSPITALITY TABLE					
1	ALE-HSA32B	Gray	31½" × 31½" × 44¼"	86 lbs.	Each 585.00

ES Series

Stylish modern seating for any workplace.

- Richly padded seats for all day support and comfort.
- Knit mesh back provides lumbar support and breathability.
- Durable steel frame and plastic molded arms.
- Manufacturer's limited five-year warranty.
- Contains 5% post-consumer recycled content, 30% total recycled content.
- Meets or exceeds ANSI/BIFMA Standards.

ID No.	Color	Shpg. Wt.	Qty.	Unit	Price
--------	-------	-----------	------	------	-------

B MESH STACK CHAIR

A modern mesh stack chair that blends perfectly in any office or waiting room. Stacks up to four high (two chairs per carton). Fully assembled. Supports up to 250 lbs. Seat: 20½" × 19¾". Back: 17¾" × 16½". Overall height: 34¼".

2	ALE-ES4314	Black	60 lbs.	2	Carton 505.00
---	------------	-------	---------	---	---------------

C MESH STOOL

A modern mesh stool perfect for hospitality and workbench settings. Two stools per carton. Supports up to 250 lbs. Seat: 20½" × 19¾". Back: 17¾" × 16½". Overall height: 46¾".

3	ALE-ES4614	Black	79 lbs.	2	Carton 555.00
---	------------	-------	---------	---	---------------

Quickly switches from conference to bistro table, sitting to standing height.



Counter Height Stacking Stool

Creative design and appealing appearance delivers unique ergonomics.

- Sculpted seat with waterfall edge maximizes comfort.
- Back with unique curvature and ventilation suits various body sizes.
- Innovative frame construction allows high density stacking.
- Welded steel frame guarantees durability and rigidity.
- Heavy density nylon glides provide stability.
- Manufacturer's limited five-year warranty.
- Meets or exceeds ANSI/BIFMA Standards.



ID No.	Color	Shpg. Wt.	Qty.	Unit	Price
--------	-------	-----------	------	------	-------

D STACKING STOOL

Supports up to 250 lbs. Seat: 17¾" × 18". Back: 18¾" × 13¼". Overall height: 40¾".

4	AAP-BS612	Black	44 lbs.	2	Carton 399.00
---	-----------	-------	---------	---	---------------

Prices subject to change without notice.
Visit our website for the latest pricing and product information.

Tables Occasional



Valencia™ Series Occasional Table

Simple classic design blends seamlessly into any decor.

- Durable woodgrain laminate is water-, scratch- and dent-resistant featuring 3 mm protective edge banding.
- Leveling glides to compensate for uneven floors.
- Easy to assemble, just add legs.
- Manufacturer's limited five-year warranty.
- Meets or exceeds ANSI/BIFMA Standards.

ID No.	Color	Size	Shpg. Wt.	Unit	Price
B COFFEE TABLE					
4	ALE-VA7548BK	Black	47¼" × 20" × 16¾"	42 lbs.	Each 190.00
5	ALE-VA7548MY	Mahogany	47¼" × 20" × 16¾"	42 lbs.	Each 190.00
6	ALE-VA7548MC	Medium Cherry	47¼" × 20" × 16¾"	42 lbs.	Each 190.00
C CORNER TABLE					
7	ALE-VA7524BK	Black	23¾" × 23¾" × 20¾"	32 lbs.	Each 150.00
8	ALE-VA7524MY	Mahogany	23¾" × 23¾" × 20¾"	32 lbs.	Each 150.00
9	ALE-VA7524MC	Medium Cherry	23¾" × 23¾" × 20¾"	32 lbs.	Each 150.00
END TABLE (not shown)					
10	ALE-VA7520BK	Black	23¾" × 20" × 20¾"	28 lbs.	Each 140.00
11	ALE-VA7520MY	Mahogany	23¾" × 20" × 20¾"	28 lbs.	Each 140.00
12	ALE-VA7520MC	Medium Cherry	23¾" × 20" × 20¾"	28 lbs.	Each 140.00



Occasional Table

Sleek, stylish and sturdy.

- Extra thick durable woodgrain laminate table top is water-, scratch-, and dent-resistant.
- Durable steel frames for a modern look and increased durability.
- Leveling glides to compensate for uneven floors. Laminate top.
- Manufacturer's limited five-year warranty.
- Meets or exceeds ANSI/BIFMA Standards.

ID No.	Color	Size	Shpg. Wt.	Unit	Price
A COFFEE TABLE					
1	ALE-CT7648M	Mahogany/Silver	47¼" × 20" × 16"	45 lbs.	Each 300.00
CORNER TABLE (not shown)					
2	ALE-CT7624M	Mahogany/Silver	23¾" × 23¾" × 20"	31 lbs.	Each 230.00
END TABLE (not shown)					
3	ALE-CT7620M	Mahogany/Silver	23¾" × 20" × 20"	30 lbs.	Each 215.00

Round Occasional Table

Modern occasional tables to create the perfect accent in any décor.

- Round laminate tops seem to float on the silver metal base.
- Durable woodgrain laminate top is water-, scratch-, and dent-resistant.
- Includes pads to keep floors scratch free.
- Manufacturer's limited five-year warranty.
- Meets or exceeds ANSI/BIFMA Standards.

ID No.	Color	Size	Shpg. Wt.	Unit	Price
D COFFEE TABLE					
13	ALE-CT7730B	Black	29¾" dia. × 15½"	28 lbs.	Each 250.00
E CORNER TABLE					
14	ALE-CT7721B	Black	21¼" dia. × 22¾"	19 lbs.	Each 200.00

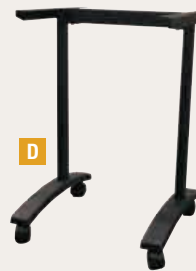

Reversible Laminate Table Top

Take your pick. Multiple sizes and colors to create your own unique desk, table or workstation.

- Reversible table tops have a different color and pattern on each side with coordinating dark gray edge banding.
- Use with Alera® bases to create height adjustable workstations, training tables, collaborative spaces or standard desks.
- Durable laminate is water-, scratch-, and dent-resistant.
- Coordinating colors with Alera® Valencia, Sedina and Open Office Suites.
- Commercial grade, 1" thick top.
- Manufacturer's limited five-year warranty.
- Meets or exceeds ANSI/BIFMA Standards.

Top and Base sold and shipped separately—ORDER BOTH.

A - B REVERSIBLE TABLE TOP

ID No.	Color	W x D	Shpg. Wt.	Unit	Price
A RECTANGULAR TOP					
1	ALE-TT7230EW	Espresso/Walnut	72" x 30"	62 lbs.	Each 219.00
2	ALE-TT7230CM	Medium Cherry/Mahogany	72" x 30"	62 lbs.	Each 219.00
3	ALE-TT7230WG	White/Gray	72" x 30"	62 lbs.	Each 219.00
4	ALE-TT7224EW	Espresso/Walnut	72" x 24"	51 lbs.	Each 159.00
5	ALE-TT7224CM	Medium Cherry/Mahogany	72" x 24"	51 lbs.	Each 159.00
6	ALE-TT7224WG	White/Gray	72" x 24"	51 lbs.	Each 159.00
7	ALE-TT6030EW	Espresso/Walnut	60" x 30"	52 lbs.	Each 189.00
8	ALE-TT6030CM	Medium Cherry/Mahogany	60" x 30"	52 lbs.	Each 189.00
9	ALE-TT6030WG	White/Gray	60" x 30"	52 lbs.	Each 189.00
10	ALE-TT6024EW	Espresso/Walnut	60" x 24"	43 lbs.	Each 139.00
11	ALE-TT6024CM	Medium Cherry/Mahogany	60" x 24"	43 lbs.	Each 139.00
12	ALE-TT6024WG	White/Gray	60" x 24"	43 lbs.	Each 139.00
13	ALE-TT4824EW	Espresso/Walnut	48" x 24"	36 lbs.	Each 119.00
14	ALE-TT4824CM	Medium Cherry/Mahogany	48" x 24"	36 lbs.	Each 119.00
15	ALE-TT4824WG	White/Gray	48" x 24"	36 lbs.	Each 119.00
16	ALE-TT3624EW	Espresso/Walnut	36" x 24"	28 lbs.	Each 89.00
17	ALE-TT3624CM	Medium Cherry/Mahogany	36" x 24"	28 lbs.	Each 89.00
18	ALE-TT3624WG	White/Gray	36" x 24"	28 lbs.	Each 89.00
B HALF-ROUND TOP					
19	ALE-TTHR48EW	Espresso/Walnut	48" x 24"	30 lbs.	Each 119.00
20	ALE-TTHR48CM	Medium Cherry/Mahogany	48" x 24"	30 lbs.	Each 119.00
21	ALE-TTHR48WG	White/Gray	48" x 24"	30 lbs.	Each 119.00

Training/Meeting Room Table Bases

Large tables provide hours of comfort during meetings or training sessions yet flip down and nest neatly for compact storage.

- Durable powder-coated steel table bases withstand constant use and resist chipping and scratching.
- Four locking canisters mobility or four glides for fixed usage.
- Accepts any table-tops.
- Manufacturer's limited five-year warranty.
- Meets or exceeds ANSI/BIFMA Standards.

C FLIP-DOWN TABLE BASE

Integrated cable management channels, ganging clips and flip down lever to fold and nest tables.

ID No.	Height	Color	Shpg. Wt.	Unit	Price
For 60" and 72" Tops					
22	ALE-VA737260BK	28"	Black	42 lbs.	Kit 310.00
For 36" and 48" Tops					
23	ALE-VA734836BK	28"	Black	29 lbs.	Kit 280.00

D FIXED T-LEG BASES

29" high with top.

ID No.	Height	Color	Shpg. Wt.	Unit	Price
For 72" and 60" Tops					
24	ALE-VA7476BK	28 3/4"	Black	24 lbs.	Kit 230.00
For 48" and 36" Tops					
25	ALE-VA7443BK	28 3/4"	Black	20 lbs.	Kit 200.00

Prices subject to change without notice. Visit our website for the latest pricing and product information.

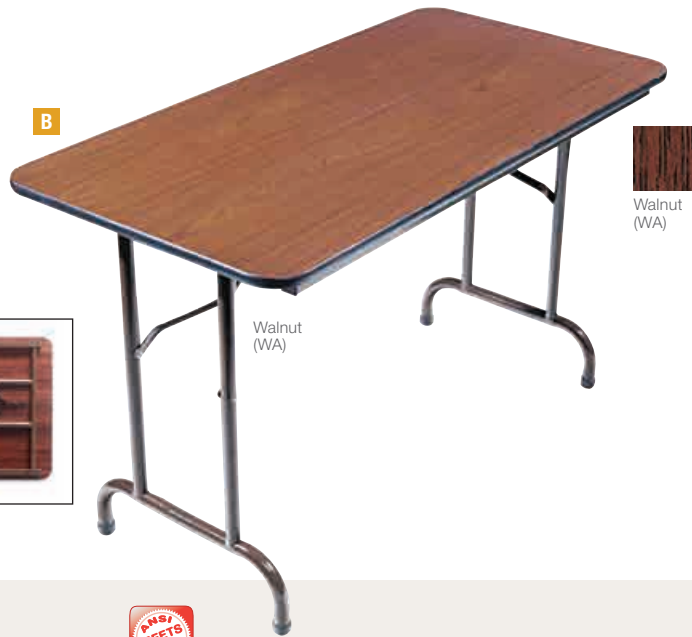

Stainless Steel Table

18 gauge stainless steel table provide great work surfaces for any area from a kitchen to a factory.

- The T430 top is National Sanitation Foundation approved for use with food, is corrosive and heat-resistant, and has a 2" rooked edge.
- Two "C" channels under the top provide additional strength, preventing the table from sagging over time.
- The base and shelf are galvanized steel.
- The shelf is fully adjustable giving the user the flexibility they need for a variety of tasks.
- Stainless Steel top supports up to 800 lbs. evenly distributed.
- Manufacturer's one-year warranty.

Wood Folding Table

Space-saving design folds table neatly when not in use.

- Folds to 2-1/2" thick and locks for easy storage.
- Scratch- and dent-resistant top.
- Gravity leg-locking mechanism for easy set-up.
- One piece brown steel apron.
- Melamine top.
- Sealed underside to prevent warping.
- Holds up to 1,200 lbs. evenly distributed.
- Melamine top supports up to 1,200 lbs. evenly distributed.
- Manufacturer's limited five-year warranty.
- Meets or exceeds ANSI/BIFMA Standards.

A STAINLESS STEEL TABLE

ID No.	Color	Size	Shpg. Wt.	Unit	Price
1 ALE-XS7230	Silver	72" x 30" x 35"	94 lbs.	Each	600.00
2 ALE-XS6030	Silver	60" x 30" x 35"	82 lbs.	Each	550.00
3 ALE-XS4830	Silver	48" x 30" x 35"	69 lbs.	Each	480.00
4 ALE-XS3630	Silver	36" x 30" x 35"	56 lbs.	Each	450.00

B WOOD FOLDING TABLE

ID No.	Color	Size	Shpg. Wt.	Unit	Price
5 ALE-FT727230WA	Walnut	72" x 29 3/4" x 29"	55 lbs.	Each	200.00
6 ALE-FT727218WA	Walnut	72" x 18" x 29"	39 lbs.	Each	180.00
7 ALE-FT726030WA	Walnut	60" x 29 3/4" x 29"	48 lbs.	Each	190.00
8 ALE-FT726018WA	Walnut	60" x 18" x 29"	34 lbs.	Each	160.00
9 ALE-FT724824WA	Walnut	48" x 24" x 29"	36 lbs.	Each	180.00



Underside Banquet Table



Adjustable Height



Resin Folding Tables

A RESIN BANQUET FOLDING TABLE

Tables for indoor and outdoor usage. Blow-molded, high-density polyethylene top is dent, scratch, stain and water resistant. Legs fold into underside cavity. Folds to 2" storage. Charcoal gray powder coated 1" steel tub legs with non-marring feet. Blow-Molded High-Density Polyethylene top supports up to 1,000 lbs. evenly distributed. Manufacturer's limited ten-year warranty. Contains 35% pre-consumer recycled content, 35% total recycled content. Meets or exceeds ANSI/BIFMA Standards.

ID No.	Color	W x D x H	Shpg. Wt.	Unit	Price
Banquet Tables —Holds up to 1,000 lbs. evenly distributed. Square edge.					
1	ALE-65601	Platinum 96" x 30" x 29"	49 lbs.	Each	265.00
2	ALE-65600	Platinum 72" x 30" x 29"	36 lbs.	Each	180.00
3	ALE-65602	Platinum 60" x 30" x 29"	31 lbs.	Each	160.00
4	ALE-65603	Platinum 48" x 24" x 29"	25 lbs.	Each	150.00

B FOLD-IN-HALF RESIN FOLDING TABLE

Resin top supports up to 1,200 lbs. evenly distributed. Convenient flip-out handle and casters to facilitate transport. Manufacturer's limited five-year warranty.

ID No.	Color	W x D x H	Shpg. Wt.	Unit	Price
5	ALE-FR72H	White 71" x 30" x 29"	35 lbs.	Each	190.00

Blow Molded Height-Adjustable Folding Table

This table is lightweight and built for heavy duty use.

- Strong steel ladder frame provides superior support.
- Easily adjustable in one inch increments.
- Resin top is waterproof and impact-, scratch- and stain-resistant.
- Legs fold into underside cavity. Leg clip keeps legs secured when not in use.
- Black steel tube legs with non-marring feet.
- Blow-Molded resin top.
- Supports up to 250 lbs. evenly distributed.
- Manufacturer's limited ten-year warranty.

C BLOW MOLDED RESIN TOP FOLDING TABLE

ID No.	Color	W x D x H	Shpg. Wt.	Unit	Price
22"-32" Adjustable Height					
6	ALE-FA307223	Gray Granite 72" x 30" x 22"-32"	44 lbs.	Each	405.00
7	ALE-FA306023	Gray Granite 60" x 30" x 22"-32"	39 lbs.	Each	385.00

D CHAIR/TABLE CART

Adjustable to accommodate most styles of folding chairs/tables. Convenient steel construction cart can be used as both a folding chair cart or table cart. Adjustable U-bar keeps folding chairs from falling over during transport. U-bar is removable for table storage. Heavy-duty casters; two locking. Holds up to 600 lbs. Includes safety strap. Manufacturer's limited five-year warranty.

ID No.	Finish	W x D	Shpg. Wt.	Unit	Price
8	ALE-FTCART	Black 20 3/4" x 50 3/4" to 75 3/4"	60 lbs.	Each	555.00

17-AL-L-A3L



See more Alera products at www.aleradetails.com

Office Furnishings

Complete your space with these all-important accessories.



These are the details that make all the difference. Fans and heaters that keep you comfortable year round. Lamps that shine a light on important tasks and bring a bit of atmosphere. And for a really cool addition to any space, compact refrigerators in sizes to fit just about anywhere. Add these indispensable extras to make a great workspace even better.

Fans & Heaters.....	85
Lamps.....	86
Refrigerators.....	87



A 4" MINI PERSONAL COOLING FAN

A perfectly sized fan to keep you cool without taking up valuable work space. Full 360 degree tilt to circulate air in any direction. Metal grill with 4" metal blades for long-lasting durability. Manufacturer's limited one-year warranty.

ID No.	Color	W x D x H	Unit	Price
1 ALE-FAN041 ★	Black	6" x 3¾" x 5¾"	Each	49.00

★ ETL Certified.

B 12" 3-SPEED OSCILLATING DESK FAN

Oscillating fan provides smooth cooling air-flow. 12" diameter fan blades provide ample air circulation and minimal noise. Features three-speed settings, oscillation on/off control and vertical tilt adjustability. 80° oscillation for wide area coverage. Manufacturer's limited one-year warranty.

ID No.	Color	W x D x H	Unit	Price
2 ALE-FAN122 ★	White	13¾" x 10¾" x 19"	Each	39.00

★ ETL Certified.

C 36" 3-SPEED OSCILLATING TOWER FAN WITH REMOTE CONTROL

Clever and quiet tower design makes the most of tight spaces. 75° oscillation circulates cool air throughout the whole room. Features three-speed settings, oscillation on/off control, wind modes, and eight-hour automatic shut-off timer. Multi-function remote control and LED display for added convenience. Manufacturer's limited one-year warranty.

ID No.	Color	W x D x H	Unit	Price
3 ALE-FAN363 ★	Black	11¾" x 11¾" x 36"	Each	99.00

★ ETL Certified.

D 16" SUPER-CIRCULATION 3-SPEED TILT FAN

Large 16" diameter blades quickly cools down your space. Clever wind-tunnel style design with five fan blades provides quiet, smooth air-flow to keep air circulating. Durable construction and high-velocity are ideal for large spaces, offices, workshops, or garages. Features three speed settings and full 360 degree tilt fan head. Manufacturer's limited one-year warranty.

ID No.	Color	W x D x H	Unit	Price
4 ALE-FAN163 ★	Black	20½" x 6½" x 19¼"	Each	49.00

★ ETL Certified.

E CERAMIC HEATER

Lightweight table-top heater for easy portability. Air is heated by an efficient ceramic heating element and circulated around the room by a fan. Adjustable thermostat up to 1500 watt heating output. Designed with safety in mind with overheat auto-shut off protection, tip-over safety switch, and a cool-to-the-touch plastic housing. Quiet heat or fan-only setting for all season use. Manufacturer's limited one-year warranty.

ID No.	Color	W x D x H	Unit	Price
5 ALE-HECH09 ★	Black	7¾" x 5¾" x 8¾"	Each	59.00

★ ETL Certified. Contains 30% post-consumer recycled content, 30% total recycled content.

F MINI TOWER CERAMIC HEATER

Oscillating mini-tower heater delivers heat where you need it. Air is warmed as it passes over a large ceramic and aluminum heating element. Heat is dispersed by a powerful fan. Adjustable thermostat up to 1500 watt heating output for maximum comfort. Designed with safety in mind with overheat auto-shut off protection, tip-over safety switch, and a cool-to-the-touch plastic housing. Manufacturer's limited one-year warranty.

ID No.	Color	W x D x H	Unit	Price
6 ALE-HECT17 ★	Black	7¾" x 7¾" x 17¾"	Each	99.00

★ ETL Certified. Contains 30% post-consumer recycled content, 30% total recycled content.

G TOWER CERAMIC HEATER WITH REMOTE CONTROL

Oscillating tower heater is perfect to heat up your room. Air is warmed as it passes over a large ceramic and aluminum heating element. Heat is dispersed by a powerful fan. Programmable digital thermostat can be set to your ideal temperature. Up to 1500 watt heating output for maximum comfort. Auto-off timer up to 15 hours. Designed with safety in mind with overheat auto-shut off protection, tip-over switch, and a cool-to-the-touch plastic housing. Includes remote control. Manufacturer's limited one-year warranty.

ID No.	Color	W x D x H	Unit	Price
7 ALE-HECT23 ★	Black	9¼" x 8¾" x 23½"	Each	129.00

★ ETL Certified. Contains 30% post-consumer recycled content, 30% total recycled content.

H HEATER FAN

Compact heater provides heat just where you need it. Air is heated by a coiled metal heating element and circulated by a fan. Three-way adjustable thermostat with up to 1500 watt heating output. Designed with safety in mind with overheat auto-shut off protection, tip-over safety switch, and a cool-to-the-touch plastic housing. Quiet heat or fan-only setting for all-season use. Manufacturer's limited one-year warranty.

ID No.	Color	W x D x H	Unit	Price
8 ALE-HEFF10 ★	Black	8¼" x 4¾" x 9¾"	Each	39.00

★ ETL Certified. Contains 30% post-consumer recycled content, 30% total recycled content.

I QUARTZ TOWER HEATER

Make your cold space comfortable quickly with this quiet tower heater. Glowing quartz-elements radiate heat directly forward for immediate warmth. Adjustable thermostat up to 1500 watt heating output. Designed with safety in mind with overheat auto-shut off protection, tip-over safety switch, and a cool-to-the-touch carry handle. Manufacturer's limited one-year warranty.

ID No.	Color	W x D x H	Unit	Price
9 ALE-HEQZ23 ★	White	13¼" x 10¾" x 23¼"	Each	129.00

★ ETL Certified. Contains 30% post-consumer recycled content, 30% total recycled content.

Prices subject to change without notice.
Visit our website for the latest pricing and product information.

Office Furnishings Lamps



ID	Key No.	Description	Height	Color	Standards	Light Bulb (incl.)	Price EA	Replacement Bulb*
Floor Lamps								
1	A ALE-LMPF72B	Floor Lamp	71"	Matte Black	ETL Certified	3-Way 1 1/20/26W CFL	69.00	SND-S7341
2	B ALE-LMPF52B	Torchier Floor Lamp	72"	Matte Black	ETL Certified	3-Way 1 1/20/26W CFL	99.00	SND-S7341
Traditional Banker's Lamps								
3	C ALE-LMP557AB	Traditional Banker's Lamp, Green Shade	13 3/4"	Antique Brass	ETL Certified	13W CFL	106.07	GEL-71804
4	C ALE-LMP517AB	Banker's Lamp with Integrated USB charging port	15"	Antique Brass	ETL Certified	13W CFL	99.00	GEL-71804
5	D ALE-LMP537BZ	Banker's Lamp, Amber Shade	16"	Antique Bronze	ETL Certified	13W CFL	79.00	GEL-71804
Adjustable Desk Lamps								
6	E ALE-LED932B	LED Task Desk Lamp	17"	Black	ETL Certified	3W LED	49.00
Adjustable CFL Task Lamps								
7	F ALE-LMP832B	LED Task Desk Lamp	16"	Matte Black	ETL Certified	13W CFL bulb	99.00	GEL-71804
Magnifier Desk Lamps								
8	G ALE-LMPM745B	Full Spectrum Clamp-On Magnifier Lamp	33 1/4"	Black	ETL Certified	22W full-spectrum bulb	99.00	SDN-S6500
Adjustable Full Spectrum Fluorescent Desk Lamps								
9	H ALE-LMPD28B	Full Spectrum "Daylight" Architect Lamp	25"	Matte Black	ETL Certified	13W full-spectrum bulb	69.00	SDN-S8310
Adjustable Architect Style Desk Lamps								
10	I ALE-LMP702B	Clamp-on Architect Lamp	28"	Black	ETL Certified	13W CFL bulb	49.00	GEL-71804
11	J ALE-LMP603B	Architect Desk Lamp	22"	Black	ETL Certified	13W CFL bulb	49.00	GEL-71804

ALE-LMPF72B, ALE-LMPF52B, ALE-LMP557AB, ALE-LMP517AB, ALE-LMP537BZ, ALE-LED932B, ALE-LMP832B, ALE-LMPM745B, ALE-LMPD28B, ALE-LMP702B, ALE-LMP603B—Manufacturer's limited one-year warranty.
*See page 335 for Replacement Bulbs.



See more Alera products at www.aleradetails.com

C



A 3.3 CU. FT. REFRIGERATOR WITH CHILLER COMPARTMENT

Counter-height fridge is ideal for breakrooms, offices or household use. Lightweight, quiet, easy-to-use, low-electric consumption refrigerator is perfect in any small space. Chiller compartment with door for short-term storage of frozen items. Reversible doors can be installed for left or right opening. Manufacturer's limited one-year warranty.

ID No.	Color	W × D × H	Unit	Price
1 ALE-RF333B *	Black	18 $\frac{3}{4}$ " × 17 $\frac{1}{4}$ " × 33 $\frac{3}{4}$ "	Each	369.00
2 ALE-RF333W *	White	18 $\frac{3}{4}$ " × 17 $\frac{1}{4}$ " × 33 $\frac{3}{4}$ "	Each	369.00

* Energy Star Qualified; Energy Conservation Standard Compliant; UL Approved.

B 1.6 CU. FT. REFRIGERATOR WITH CHILLER COMPARTMENT

Compact sized mini-fridge is perfect for light-duty or personal use. Lightweight, quiet, easy-to-use, low-electric consumption refrigerator is perfect in any small space. Chiller compartment with door for short-term storage of frozen items. Reversible doors can be installed for left or right opening. Manufacturer's limited one-year warranty.

ID No.	Color	W × D × H	Unit	Price
3 ALE-RF616B *	Black	18 $\frac{3}{4}$ " × 17 $\frac{1}{4}$ " × 19 $\frac{1}{2}$ "	Each	229.00
4 ALE-RF616W *	White	18 $\frac{3}{4}$ " × 17 $\frac{1}{4}$ " × 19 $\frac{1}{2}$ "	Each	229.00

* Energy Star Qualified; Energy Conservation Standard Compliant; UL Approved.

C 3.4 CU. FT. BEVERAGE COOLER

Sleek stainless steel beverage cooler keeps beverages cool and easily available. Convenient triple layer glass front door is frost-free, to better showcase drink choices. Convenient cooler provides plenty of storage, with three adjustable shelves. Holds up to 120 cans. Reversible doors can be installed left or right to fit any configuration. Comes with full-range temperature control and interior light. Quiet, low-energy consumption refrigerator/cooler is perfect in any space. Leveling glides help compensate for uneven floors. Flush back design conceals components and allows a seamless fit in tight spaces. Manufacturer's limited one-year warranty.

ID No.	Color	W × D × H	Unit	Price
5 ALE-RFBC34 *	Stainless Steel/Black	19 $\frac{3}{4}$ " × 17 $\frac{3}{4}$ " × 33 $\frac{1}{2}$ "	Each	499.00

* Energy Conservation Standard Compliant; Energy Star Qualified; CSA Energy Efficiency Mark; UL Approved; Energy Star Rated.

Prices subject to change without notice.
Visit our website for the latest pricing and product information.

ANSI/BIFMA Testing



The following tests were developed by the Business and Institutional Furniture Manufacturer's Association (BIFMA) and approved by the American National Standards Institute (ANSI). These performance tests determine the stamina of casegoods and seating in their day-to-day use on a single work shift over ten years. Concentrated load tests represent normal use conditions. Distributed loads represent excessive use conditions. All of our manufacturers recognize the value of building product to ANSI/BIFMA standards while only some manufacturers go to the added expense of having their products certified. Look for the ANSI/BIFMA symbol in this catalog to identify products that meet or exceed the ANSI/BIFMA standards.

Casegood Testing Standards

Durability Test

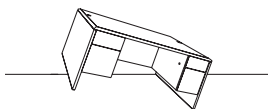

Drop Test

Each end is picked up and dropped to evaluate how well desk withstands impact on legs or base.

Top Load Tests

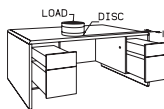

Concentrated Load Test

200 lbs. applied through 12" diameter at weakest point to ensure that no structural damage occurs from concentrated loads.



Distributed Load Test

1.5 lbs. per inch of perimeter applied to ensure that no personal injury results from distributed loads.

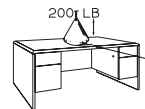

Ease Load Test

200-lb. bag lifted and dropped 10,000 times to test durability of desktop to endure cyclic loading.

Drawer Tests

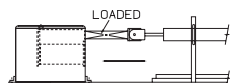

Cycle Test

Drawer is filled with .017-lb./cubic inch of volume and cycled 50,000 times to test support of common loads under normal operating conditions.

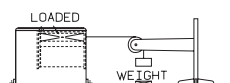

Outstop Test

Weighted load pulls drawer completely open 15,000 times to evaluate the effectiveness of outstops.

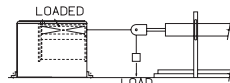

Pull Test

Measure of force needed to pull drawer open when filled with .017-lb./cubic inch of volume.

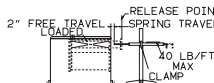

Rebound Test

Drawer is loaded, opened and forced closed 5 times to ensure drawer won't rebound over 1 1/2".

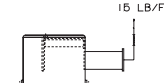

Retention Test

Unloaded open drawer has an outward force applied to ensure drawer won't accidentally disengage.

Other Tests

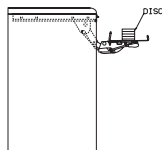

Adjustable Keyboard Surface Load Test

Tests keyboard drawer durability through 2,500 horizontal, 2,500 vertical and 2,500 swivel adjustments with a 10-lb. concentrated load.

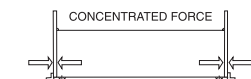

Leg Strength Test

100 lbs. of concentrated force inward and 50 lbs. of concentrated force outward on legs to test stability and support.

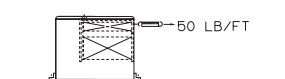

Lock Strength Test

50 lbs. of outward force applied to evaluate strength of locking mechanism.

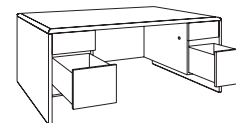

Stability Test

Largest drawer in each pedestal is opened and loaded to ensure desk won't tip when full.

Seating Testing Standards

Back Strength Tests



Swivel/Tilt Test

200 lbs. of concentrated force applied; 300 lbs. of distributed force applied.

Task/Guest Test

150 lbs. of concentrated force applied; 250 lbs. of distributed force applied.

Back Durability Tests



Swivel/Tilt Test

Chair is fully reclined 120,000 times by 225 lbs. of force with a 225-lb. load on seat.

Task/Guest Test

Chair is tilted 120,000 times by 75 lbs. of force with a 225-lb. load on seat.

Drop Weight Tests



Seating Impact Tests

125-lb. weight dropped onto seat 100,000 times.

6" Drop Test

A 225-lb. concentrated load dropped 6" onto seat then a 300-lb. distributed load dropped 6" onto seat.

Base Tests

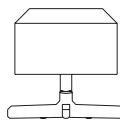

Base Tests

2,500 lbs. of concentrated force applied on base then 2,500 lbs. of distributed force applied on base for one minute each load.

Stability Tests



Front Stability Tests

135 lbs. centered 2.4" from front edge of seat. Chair must be able to take 4.5 lbs. of horizontal force without tipping over.



Back Stability Tests

No less than 20 lbs. of pressure should be required to tip the chair back with 173 lbs. on seat.

Caster Tests

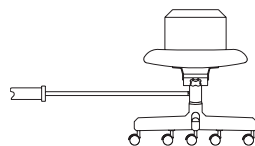

Caster Durability Test

Rolled along a 30" distance 100,000 times with a 250-lb. load.

Armrest Strength Tests

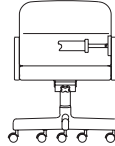

Outward Force Arm Test

A load force is applied outward on the arm; then 150 lbs. of distributed force is applied.

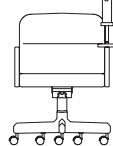

Downward Force Arm Test

A load force is pulled downward on the arm; then 300 lbs. of distributed force is applied.

Footring Tests

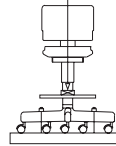

Footring Durability Test

200 lbs. of weight applied along a 4" length of footring 50,000 times.

Swivel Tests



Swivel Cycle Test

Base is rotated 120,000 times with 225 lbs. on seat.